



**PUBLIC WORKS DEPARTMENT
MEMORANDUM #2011 – 29**

DATE: July 28, 2011
TO: Honorable Mayor Joyce Downing and City Council Members
FROM: William A. Simmons, City Manager 
David H. Willett, Director of Public Works 
SUBJECT: CR-71 2011 Process Control System Programming

BACKGROUND

The City of Northglenn's utility system consists of a water treatment facility, wastewater treatment facility, approximately 126 miles of water lines and 100.6 miles of sanitary sewer lines, four water storage tanks, 10 lift stations and 1 pump station. All major pieces of equipment in the aforementioned facility classes are equipped with process control systems to assist staff with daily operations. These control systems operate and collect data from the equipment providing continuous monitoring capabilities and operations as well as enhancing ability to maintain regulatory compliance and the protection of public health. Regular maintenance and/or replacement of the control systems must be provided in order to ensure continuous operation of the equipment and to meet the evolving regulatory requirements.

On May 11, 2011, the City of Northglenn requested proposals from consulting firms to provide electrical engineering and process control system programming services necessary to maintain these critical control systems for the 2011 and 2012 calendar years. The Request for Proposal (RFP) included a request for electrical and control system services associated with the water and wastewater treatment and conveyance for the 2011 and 2012 calendar year and is structured on a time and materials basis with the option to extend the contract an additional year.

On May 26, 2011, the City accepted four (4) proposals for the 2011 Process Control System Programming. The four proposals received were from Carollo Engineers, Integrated Solutions Engineering, Golder Associates, and Browns Hill Engineering and Controls. Integrated Solutions Engineering was the firm selected based on staff review of the responses provided in the Request for Proposal. Selection criteria/ranking sheets and hourly rates are attached for reference. City staff contacted the submitted references and determined that the consultant's past performance on similar projects meets the City's standards. Copies of the standard agreement are attached.

Awarding the Process Control System Programming is the first phase of our Supervisory Control and Data Acquisition (SCADA) system upgrade. Integrated Solutions Engineering will complete necessary programming maintenance, engineering, and drawings for each lift station and Water Treatment Facility node. The second phase, anticipated completion in January 2011, consists of replacing our existing radios that are reaching the end of their life expectancy with new and much smaller units. Replacing our old radios will give staff additional room in our control cabinets to complete the third phase of installing the new Programmable Logic Controllers (PLCs). Because we cannot shut down our treatment processes we have to make the transition to the new PLCs one individual process at a time. The goal is to have a redundant SCADA system to ensure continuous service delivery. The SCADA schematic drawings are attached.

BUDGET/TIME IMPLICATIONS

The proposed project would be funded out of the following accounts:

CAPITAL EXPENDITURE BREAKDOWN

CIP Budgeted Amount	\$175,000.00
2011 Process Control System Programming	
CIP Water and Wastewater Fund (Engineering/Design)	\$45,000.00
Wastewater Operating/Technical Services (programming)	\$ 5,000.00
Water Operating/Technical Service (programming)	<u>\$10,000.00</u>
Contract Total	<u>\$60,000.00</u>
Balance of CIP funds to be used for Radios and PLCs	\$130,000.00

RECOMMENDATION

Attached to this memorandum is a Resolution that, if approved, would:

- 1) Authorize the Mayor to execute a contract between the City of Northglenn and Integrated Solutions Engineering for the **2011 Process Control System Programming**, in the amount of \$60,000.00, and;

Staff recommends approval of the proposed Resolution.

STAFF REFERENCE

David H. Willett, P.E., Director of Public Works
Raymond Reling, Utility Superintendent

dwillett@northglenn.org or 303.450.8783
rreling@northglenn.org or 303.450.4049



Request for Proposal Results
 2011 Process Control System Programming Technical Services
 Project Number 2011 RFP-25

BID	Carollo Engineers	Integrated Solutions Engineering	Golder Associates, Inc	Browns Hill Engineering and Controls
Hourly Rate Engineer	\$163.00	\$130.00	\$150.00	\$140.00
After Hours Rate	no cost included	\$175.00	no cost included	\$173.00 after hours \$230.00 weekends
Backup for Emergencies - Required	not included	\$135.00 normal hours \$180.00 after hours \$205.00 weekends	not included	not included
PE Electrical Engineer	yes	yes	yes	yes
Profibus Certified	yes	yes	not included	not included

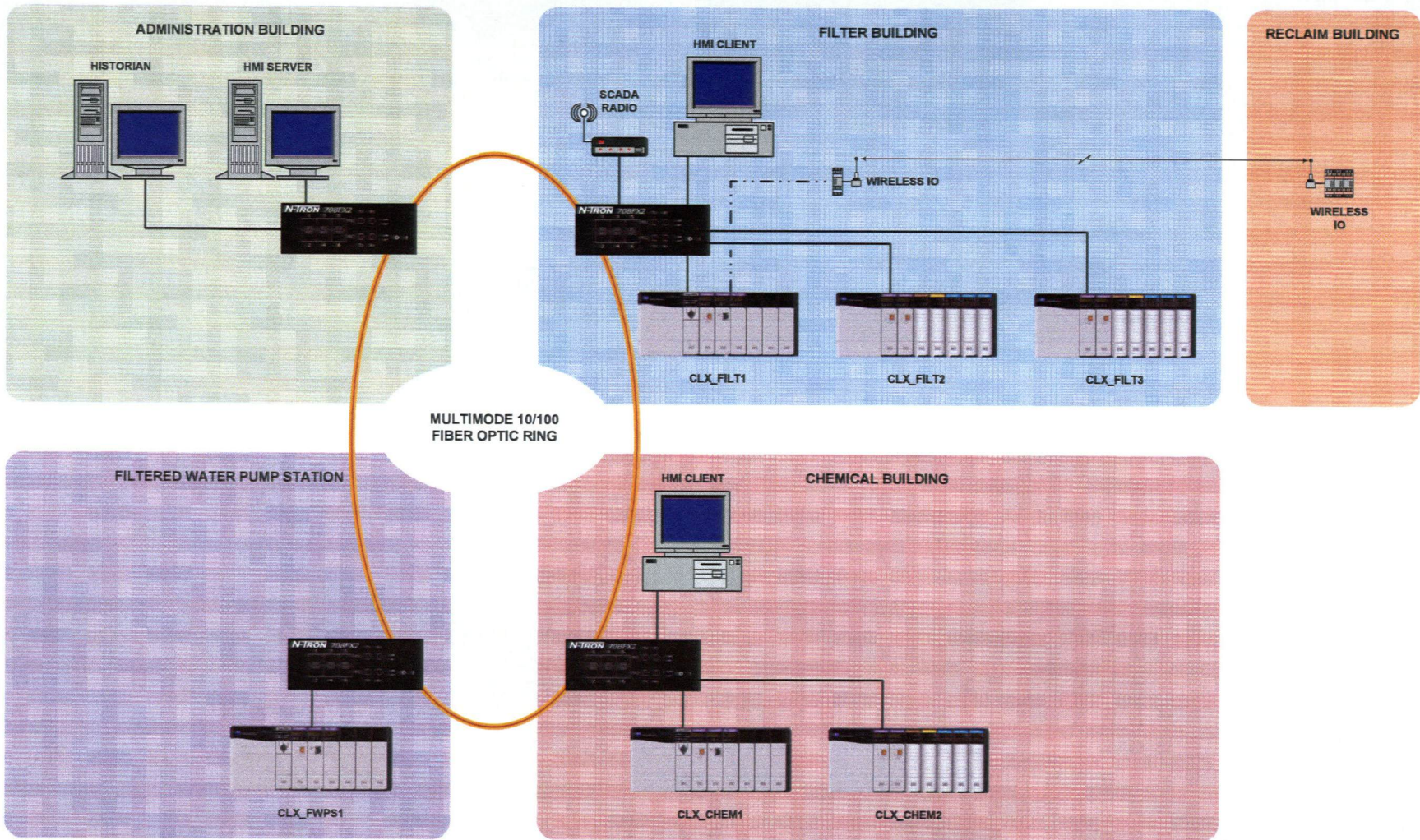

Integrated Solutions Engineering

1 Photinia
Littleton, CO 80127
Tele: 303.933.3466

REV.	DESCRIPTION	DATE	BY



**CITY OF
NORTHGLENN
COLORADO**

SCADA SYSTEM IMPROVEMENTS

**WATER TREATMENT PLANT
PROCESS CONTROL SYSTEM ARCHITECTURE**

PROJECT:	
DATE: July, 2010	
REVISED:	
FILENAME:	
DRAWN BY:	Sheet
Martin	1
APPROVED:	
Martin	

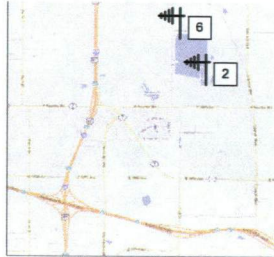

WASTEWATER TREATMENT FACILITY
NO SCALE

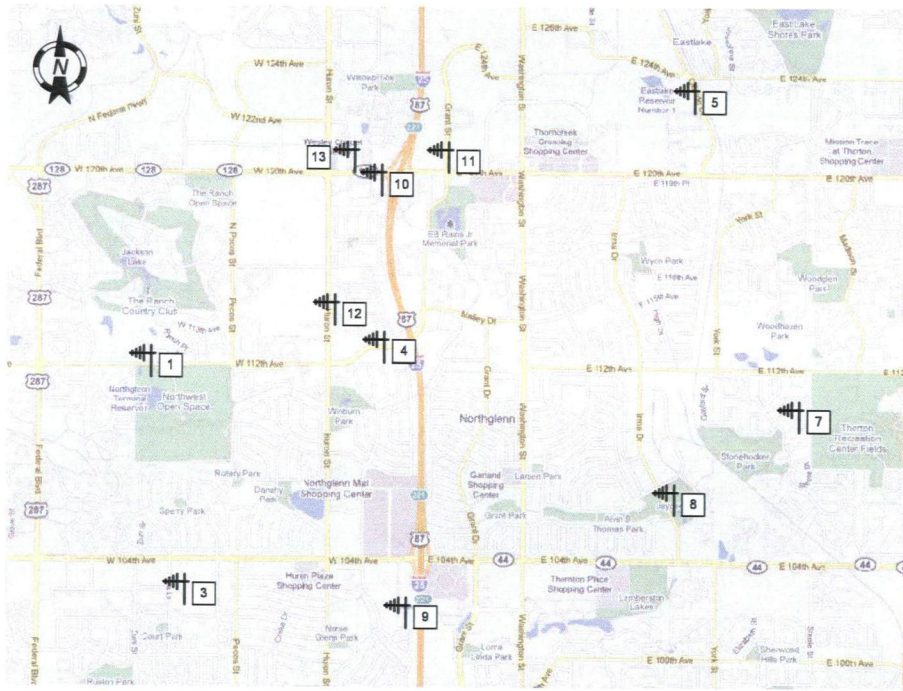

RADIO TELEMETRY SITE AREA MAP
NO SCALE

Northglenn Radio Telemetry Sites			
Site	Site Name	SCADA Function	Address
1	Water Treatment Plant	Master	2350 W. 112th Avenue
2	Wastewater Treatment Plant	Slave	5445 Weld County Rd. 2
3	High Zone Tank	Slave/Repeater	1950 W. 103rd Avenue
4	Low Zone Tanks - Booster Pump Station	Slave	11201 Cherokee St.
5	Bunker Hill	Slave	12301 Claude Ct.
6	Chlorine Building	Slave/Repeater	960 Weld County Rd. 2
7	Fox Run	Slave	10954 Fox Run Parkway
8	Lift Station A	Slave	10580 Irma Drive
9	Lift Station B	Slave	10150 Bannock St.
10	Lift Station E	Slave	11900 Delaware St.
11	Lift Station F	Slave	200 E. 120th Avenue
12	Lift Station G	Slave	11360 Huron St.
13	Lift Station H	Slave	500 W. 120th Avenue

Integrated Solutions Engineering

1 Photinia
Littleton, CO 80127
Tele: 303.933.3466

REV.	DESCRIPTION	DATE	BY



**CITY OF
NORTHGLENN
COLORADO**

SCADA SYSTEM IMPROVEMENTS

SCADA RADIO SYSTEM AREA MAPS

PROJECT:
DATE: July, 2010
REVISED:
FILENAME:
DRAWN BY:
Martin
APPROVED:
Martin

Sheet
2

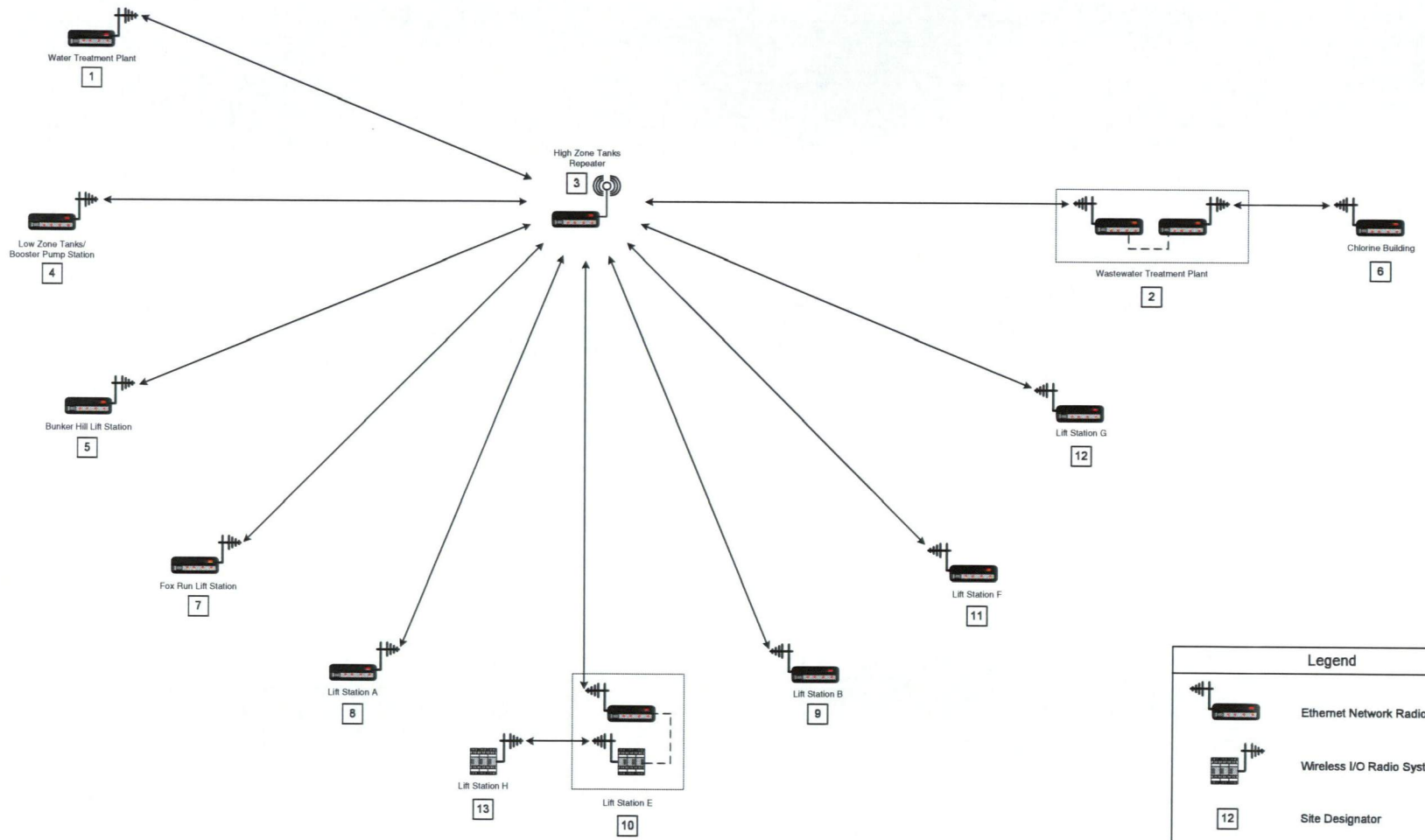

RADIO SYSTEM ARCHITECTURE
No Scale

Legend	
	Ethernet Network Radio
	Wireless I/O Radio System
	Site Designator
	Radio Propagation Path
	Hardwire Data Link

Integrated Solutions Engineering

1 Photinia
Littleton, CO 80127
Tele: 303.933.3466

REV.	DESCRIPTION	DATE	BY



CITY OF NORTHGLENN COLORADO

SCADA SYSTEM IMPROVEMENTS

RADIO SYSTEM ARCHITECTURE

PROJECT:	
DATE:	July, 2010
REVISED:	
FILENAME:	
DRAWN BY:	Martin
APPROVED:	Martin
Sheet	3

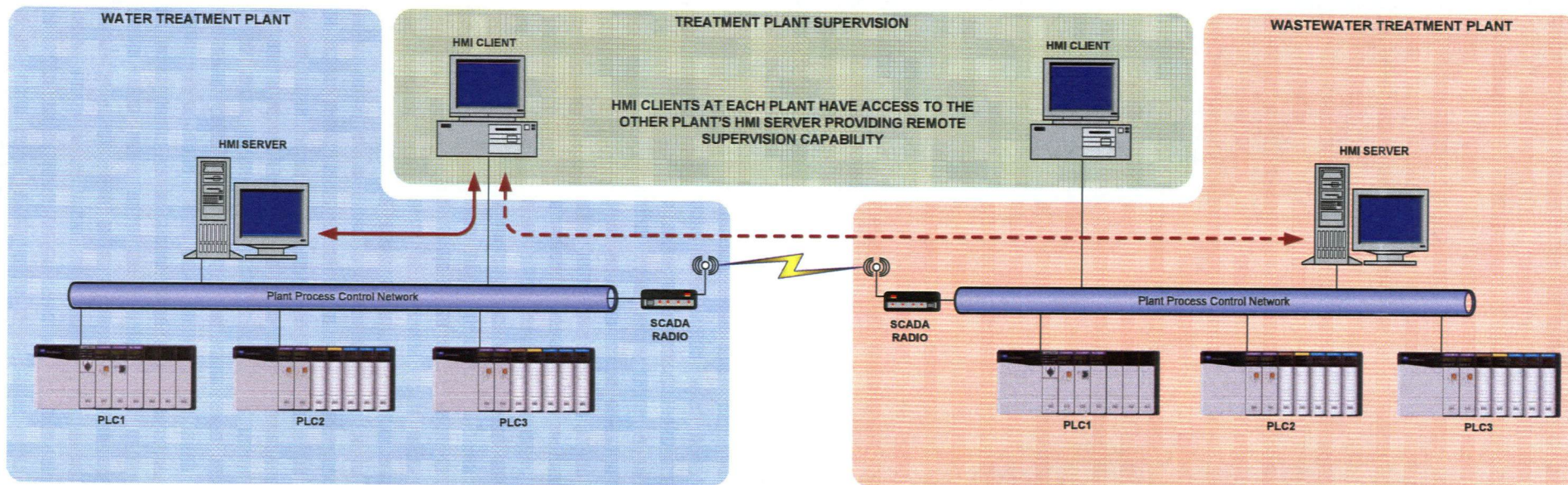

Integrated Solutions Engineering

1 Pholinia
Littleton, CO 80127
Tele: 303.933.3466

REV.	DESCRIPTION	DATE	BY



**CITY OF
NORTHGLENN
COLORADO**

SCADA SYSTEM IMPROVEMENTS

**SIMPLE NETWORK DIAGRAM
REMOTE SUPERVISION CAPABILITY**

PROJECT:	
DATE:	July, 2010
REVISED:	
FILENAME:	
DRAWN BY:	Martin
APPROVED:	Martin
Sheet	4

SPONSORED BY: MAYOR DOWNING

COUNCILMAN'S RESOLUTION

RESOLUTION NO.

No. CR-71
Series of 2011

Series of 2011

A RESOLUTION APPROVING A PROFESSIONAL SERVICES AGREEMENT BETWEEN THE CITY OF NORTHGLENN AND INTEGRATED SOLUTIONS ENGINEERING FOR THE 2011 PROCESS CONTROL SYSTEM PROGRAMMING PROJECT

BE IT RESOLVED BY THE CITY COUNCIL OF THE CITY OF NORTHGLENN, COLORADO, THAT:

Section 1. The Professional Services Agreement between the City of Northglenn and Integrated Solutions Engineering, attached hereto, in an amount not to exceed \$60,000.00 for the 2011 Process Control System Programming Project is hereby approved and the Mayor is authorized to execute same on behalf of the City of Northglenn.

DATED at Northglenn, Colorado, this ____ day of _____, 2011.

JOYCE DOWNING
Mayor

ATTEST:

JOHANNA SMALL, CMC
City Clerk

APPROVED AS TO FORM:

COREY Y. HOFFMANN
City Attorney

AGREEMENT FOR PROFESSIONAL SERVICES

THIS AGREEMENT is made and entered into this ____ day of _____, 2011, by and between the City of Northglenn, State of Colorado (hereinafter referred to as the "City") and Integrated Solutions Engineering (hereinafter referred to as "Consultant").

RECITALS:

A. The City requires professional services.

B. Consultant has held itself out to the City as having the requisite expertise and experience to perform the required work for the Project.

NOW, THEREFORE, it is hereby agreed for the consideration hereinafter set forth, that Consultant shall provide to the City, professional consulting services for the Project.

I. SCOPE OF SERVICES

Consultant shall furnish all labor and materials to perform the work and services required for the complete and prompt execution and performance of all duties, obligations, and responsibilities for the Project which are described or reasonably implied from **Exhibit A** which is attached hereto and incorporated herein by this reference.

II. THE CITY'S OBLIGATIONS/CONFIDENTIALITY

The City shall provide Consultant with reports and such other data as may be available to the City and reasonably required by Consultant to perform hereunder. No project information shall be disclosed by Consultant to third parties without prior written consent of the City or pursuant to a lawful court order directing such disclosure. All documents provided by the City to Consultant shall be returned to the City. Consultant is authorized by the City to retain copies of such data and materials at Consultant's expense.

III. OWNERSHIP OF WORK PRODUCT

The City acknowledges that the Consultant's work product is an instrument of professional service. Nevertheless, the products prepared under this Agreement shall become the property of the City upon completion of the work.

IV. COMPENSATION

A. In consideration for the completion of the services specified herein by Consultant, the City shall pay Consultant an amount not to exceed sixty thousand dollars (\$60,000). Payment shall be made in accordance with the schedule of charges in **Exhibit B** which is attached hereto and incorporated herein by this reference. Invoices will be itemized and include hourly breakdown for all personnel and other charges. The maximum fee specified herein shall include all fees and expenses incurred by Consultant in performing all services hereunder.

B. Consultant may submit monthly or periodic statements requesting payment. Such request shall be based upon the amount and value of the work and services performed by Consultant under this Agreement except as otherwise supplemented or accompanied by such supporting data as may be required by the City.

1. All invoices, including Consultant's verified payment request, shall be submitted by

Consultant to the City no later than the twenty-fourth (24th) day of each month for payment pursuant to the terms of this Agreement. In the event Consultant fails to submit any invoice on or before the twenty-fourth (24th) day of any given month, Consultant defers its right to payment pursuant to said late invoice until the twenty-fourth (24th) day of the following month.

2. Progress payments may be claimed on a monthly basis for reimbursable costs actually incurred to date as supported by detailed statements, including hourly breakdowns for all personnel and other charges. The amounts of all such monthly payments shall be paid within thirty (30) days after the timely receipt of invoice as provided by this Agreement.

C. The City has the right to ask for clarification on any Consultant invoice after receipt of the invoice by the City.

D. In the event payment for services rendered has not been made within forty-five (45) days from the receipt of the invoice for any uncontested billing, interest will accrue at the legal rate of interest. In the event payment has not been made within ninety (90) days from the receipt of the invoice for any uncontested billing, Consultant may, after giving seven (7) days written notice and without penalty or liability of any nature, suspend all work on all authorized services specified herein. In the event payment in full is not received within thirty (30) days of giving the seven (7) days written notice, Consultant may terminate this Agreement. Upon receipt of payment in full for services rendered, Consultant will continue with all authorized services.

E. Final payment shall be made within sixty (60) calendar days after all data and reports (which are suitable for reproduction and distribution by the City) required by this Agreement have been turned over to and approved by the City and upon receipt by the City of Consultant's certification that services required herein by Consultant have been fully completed in accordance with this Agreement and all data and reports for the Project.

V. COMMENCEMENT AND COMPLETION OF WORK

Within seven (7) days of receipt from the City of a Notice to Proceed, Consultant shall commence work on all its obligations as set forth in the Scope of Services or that portion of such obligations as is specified in said Notice. Except as may be changed in writing by the City, the Project shall be complete and Consultant shall furnish the City the specified deliverables as provided in Exhibit A.

VI. CHANGES IN SCOPE OF SERVICES

A change in the Scope of Services shall constitute any material change or amendment of services or work which is different from or additional to the Scope of Services specified in Section I of this Agreement. No such change, including any additional compensation, shall be effective, or paid unless authorized by written amendment executed by the City. If Consultant proceeds without such written authorization, then Consultant shall be deemed to have waived any claim for additional compensation, including a claim based on the theory of unjust enrichment, quantum merit or implied contract. Except as expressly provided herein, no agent, employee, or representative of the City shall have the authority to enter into any changes or modifications, either directly or implied by a course of action, relating to the terms and scope of this Agreement.

VII. PROFESSIONAL RESPONSIBILITY

A. Consultant hereby warrants that it is qualified to assume the responsibilities and render the services described herein and has all requisite corporate authority and professional licenses in good

standing, required by law.

B. The work performed by Consultant shall be in accordance with generally accepted professional practices and the level of competency presently maintained by other practicing professional firms in the same or similar type of work in the applicable community.

C. Consultant shall be responsible for the professional quality, technical accuracy, timely completion, and the coordination of all designs, drawings, specifications, reports, and other services furnished by Consultant under this Agreement. Consultant shall, without additional compensation, correct or resolve any errors or deficiencies in his designs, drawings, specifications, reports, and other services, which fall below the standard of professional practice, and reimburse the City for construction costs caused by errors and omissions which fall below the standard of professional practice.

D. Approval by the City of drawings, designs, specifications, reports, and incidental work or materials furnished hereunder shall not in any way relieve Consultant of responsibility for technical adequacy of the work. Neither the City's review, approval or acceptance of, nor payment for, any of the services shall be construed to operate as a waiver of any rights under this Agreement or of any cause of action arising out of the performance of this Agreement, and Consultant shall be and remain liable in accordance with applicable performance of any of the services furnished under this Agreement.

E. The rights and remedies of the City provided for under this Agreement are in addition to any other rights and remedies provided by law.

VIII. ILLEGAL ALIENS

A. Certification. By entering into this Agreement, Consultant hereby certifies that, at the time of this certification, it does not knowingly employ or contract with an illegal alien who will perform work under the Agreement and that Consultant will participate in either the E-Verify Program administered by the United States Department of Homeland Security and Social Security Administration or the Department Program administered by the Colorado Department of Labor and Employment in order to confirm the employment eligibility of all employees who are newly hired for employment to perform work under the Agreement.

B. Prohibited Acts. Consultant shall not:

1. Knowingly employ or contract with an illegal alien to perform work under this Agreement; or
2. Enter into a contract with a subcontractor that fails to certify to Consultant that the subcontractor shall not knowingly employ or contract with an illegal alien to perform work under this Agreement.

C. Verification.

1. Consultant has confirmed the employment eligibility of all employees who are newly hired for employment to perform work under this Agreement through participation in either the E-Verify Program or the Department Program.
2. Consultant shall not use the E-Verify Program or the Department Program procedures to undertake pre-employment screening of job applicants while this Agreement is being performed.

3. If Consultant obtains actual knowledge that a subcontractor performing work under this Agreement knowingly employs or contracts with an illegal alien who is performing work under the Agreement, Consultant shall:

a. Notify the subcontractor and the City within three (3) days that Consultant has actual knowledge that the subcontractor is employing or contracting with an illegal alien who is performing work under the Agreement; and

b. Terminate the subcontract with the subcontractor if within three (3) days of receiving the notice required pursuant to subparagraph (a) hereof, the subcontractor does not stop employing or contracting with the illegal alien who is performing work under the Agreement; except that Consultant shall not terminate the contract with the subcontractor if during such three (3) days the subcontractor provides information to establish that the subcontractor has not knowingly employed or contracted with an illegal alien who is performing work under the Agreement.

D. Duty to Comply with Investigations. Consultant shall comply with any reasonable request by the Colorado Department of Labor and Employment made in the course of an investigation conducted pursuant to C.R.S. § 8-17.5-102(5)(a) to ensure that Consultant is complying with the terms of this Agreement.

E. If Consultant does not currently employ any employees, Consultant shall sign the NO Employee Affidavit attached hereto.

F. If Consultant wishes to verify the lawful presence of newly hired employees who perform work under the Agreement via the Department Program, Consultant shall sign the Department Program Affidavit attached hereto.

IX. INDEMNIFICATION

Consultant agrees to indemnify and hold harmless the City, its officers, employees, and insurers, from and against all liability, claims, and demands, on account of injury, loss, or damage, including without limitation claims arising from bodily injury, personal injury, sickness, disease, death, property loss or damage, if such injury, loss, or damage is caused in whole or in part by, or is claimed to be caused in whole or in part by, the negligent act, omission, error, professional error, mistake, negligence, or other fault of Consultant, any subcontractor of Consultant, or any officer, employee, representative, or agent of Consultant or of any subcontractor of Consultant, or which arise out of any workmen's compensation claim of any employee of Consultant or of any employee of any subcontractor of Consultant. Consultant agrees to investigate, handle, respond to, and to provide defense for and defend against any such liability, claims or demands at the sole expense of Consultant, or at the option of the City, agrees to pay the City or reimburse the City for the defense costs incurred by the City in connection with, any such liability, claims, or demands. Consultant also agrees to bear all other costs and expenses related thereto, including court costs and attorney fees, whether or not any such liability, claims, or demands alleged are groundless, false, or fraudulent. If it is determined by the final judgment of a court of any competent jurisdiction that such injury, loss, or damage was caused in whole or in part by the act, omission, or other fault of the City, its officers, or its employees, the City shall reimburse Consultant for the portion of the judgment attributable to such act, omission, or other fault of the City, its officers, or employees.

X. INSURANCE

A. Consultant agrees to procure and maintain, at its own cost, a policy or policies of insurance

sufficient to insure against all liability, claims, demands, and other obligations assumed by Consultant pursuant to Section IX, above. Such insurance shall be in addition to any other insurance requirements imposed by this Agreement or by law. Consultant shall not be relieved of any liability, claims, demands, or other obligations assumed pursuant to Section IX, above, by reason of its failure to procure or maintain insurance, or by reason of its failure to procure or maintain insurance in sufficient amounts, durations, or types.

B. Consultant shall procure and maintain, and shall cause any subcontractor of Consultant to procure and maintain, the minimum insurance coverages listed below. Such coverages shall be procured and maintained with forms and insurers acceptable to the City. All coverages shall be continuously maintained to cover all liability, claims, demands, and other obligations assumed by Consultant pursuant to Section IX, above. In the case of any claims-made policy, the necessary retroactive dates and extended reporting periods shall be procured to maintain such continuous coverage.

1. Workmen's compensation insurance to cover obligations imposed by applicable laws for any employee engaged in the performance of work under this Agreement, and Employer's Liability insurance with minimum limits of five hundred thousand dollars (\$500,000) each accident, one million dollars (\$1,000,000) disease - policy limit, and one million dollars (\$1,000,000) disease - each employee. Evidence of qualified self-insured status may be substituted for the workmen's compensation requirements of this paragraph.

2. Commercial general liability insurance with minimum combined single limits of six hundred thousand (\$1,000,000) each occurrence and two million dollars (\$2,000,000) general aggregate. The policy shall be applicable to all premises and operations. The policy shall include coverage for bodily injury, broad form property damage (including completed operations), personal injury (including coverage for contractual and employee acts), blanket contractual, products, and completed operations. The policy shall contain a severability of interests provision.

3. Professional liability insurance with minimum limits of six hundred thousand dollars (\$600,000) each claim and one million dollars (\$1,000,000) general aggregate.

C. The policy required by paragraph 2. above shall be endorsed to include the City and the City's officers, employees, and consultants as additional insureds. Every policy required above shall be primary insurance, and any insurance carried by the City, its officers, its employees, or its consultants shall be excess and not contributory insurance to that provided by Consultant. No additional insured endorsement to the policy required by paragraph 1. above shall contain any exclusion for bodily injury or property damage arising from completed operations. Consultant shall be solely responsible for any deductible losses under any policy required above.

D. The certificate of insurance provided for the City shall be completed by Consultant's insurance agent as evidence that policies providing the required coverages, conditions, and minimum limits are in full force and effect, and shall be reviewed and approved by the City prior to commencement of the Agreement. No other form of certificate shall be used. If the City is named as an additional insured on any policy which does not allow for the automatic addition of additional insureds, the Consultant's insurance agent shall also provide a copy of all accompanying endorsements recognizing the City as an additional insured. The certificate shall identify this Agreement and shall provide that the coverages afforded under the policies shall not be cancelled, terminated or materially changed until at least thirty (30) days prior written notice has been given to the City. The completed certificate of insurance shall be sent to:

City of Northglenn
Attn: Kathy Kvasnicka
11701 Community Center Drive
Northglenn, Colorado 80233-8061

E. Failure on the part of Consultant to procure or maintain policies providing the required coverages, conditions, and minimum limits shall constitute a material breach of agreement upon which the City may immediately terminate this Agreement, or at its discretion, the City may procure or renew any such policy or any extended reporting period thereto and may pay any and all premiums in connection therewith, and all monies so paid by the City shall be repaid by Consultant to the City upon demand, or the City may offset the cost of the premiums against any monies due to Consultant from the City.

F. The City reserves the right to request and receive a certified copy of any policy and any endorsement thereto.

G. The parties hereto understand and agree that the City, its officers, and its employees, are relying on, and do not waive or intend to waive by any provision of this Agreement, the monetary limitations (presently one hundred fifty thousand dollars (\$150,000) per person and six hundred thousand dollars (\$600,000) per occurrence) or any other rights, immunities, and protections provided by the Colorado Governmental Immunity Act, Colo. Rev. Stat. §24-10-101 et seq., Colo. Rev. Stat., as from time to time amended, or otherwise available to the City, its officers, or its employees.

XI. NON-ASSIGNABILITY

Neither this Agreement, nor any of the rights or obligations of the parties hereto, shall be assigned by either party without the written consent of the other.

XII. TERMINATION

This Agreement shall terminate at such time as the work in Section I is completed and the requirements of this Agreement are satisfied, or upon the City's providing Consultant with seven (7) days advance written notice, whichever occurs first. In the event the Agreement is terminated by the City's issuance of said written notice of intent to terminate, the City shall pay Consultant for all work previously authorized and completed prior to the date of termination. If, however, Consultant has substantially or materially breached the standards and terms of this Agreement, the City shall have any remedy or right of set-off available at law and equity. If the Agreement is terminated for any reason other than cause prior to completion of the Project, any use of documents by the City thereafter shall be at the City's sole risk, unless otherwise consented to by Consultant.

XIII. CONFLICT OF INTEREST

The Consultant shall disclose any personal or private interest related to property or business within the City. Upon disclosure of any such personal or private interest, the City shall determine if the interest constitutes a conflict of interest. If the City determines that a conflict of interest exists, the City may treat such conflict of interest as a default and terminate this Agreement.

XIV. VENUE

This Agreement shall be governed by the laws of the State of Colorado, and any legal action concerning the provisions hereof shall be brought in the County of Adams, State of Colorado.

XV. INDEPENDENT CONTRACTOR

Consultant is an independent contractor. Notwithstanding any provision appearing in this Agreement, all personnel assigned by Consultant to perform work under the terms of this Agreement shall be, and remain at all times, employees or agents of Consultant for all purposes. Consultant shall make no representation that it is the employee of the City for any purposes.

XVI. NO WAIVER

Delays in enforcement or the waiver of any one or more defaults or breaches of this Agreement by the City shall not constitute a waiver of any of the other terms or obligation of this Agreement.

XVII. ENTIRE AGREEMENT

This Agreement and the attached Exhibits A and B is the entire Agreement between Consultant and the City, superseding all prior oral or written communications. None of the provisions of this Agreement may be amended, modified, or changed, except as specified herein.

XVIII. SUBJECT TO ANNUAL APPROPRIATION

Consistent with Article X, Section 20 of the Colorado Constitution, any financial obligations the City not to be performed during the current fiscal year are subject to annual appropriation, and thus any obligations of the City hereunder shall extend only to monies currently appropriated and shall not constitute a mandatory charge, requirement or liability in any ensuing fiscal conflicting provisions in the Agreement establishing any monetary obligation beyond the current fiscal year.

XIX. NOTICE

Any notice or communication between Consultant and the City which may be required, or which may be given, under the terms of this Agreement shall be in writing, and shall be deemed to have been sufficiently given when directly presented or sent pre-paid, first class United States Mail, addressed as follows:

The City: City of Northglenn
11701 Community Center Drive
Northglenn, Colorado 80233-8061

Consultant: Integrated Solutions Engineering
1 Photinia
Littleton, Colorado 80127

IN WITNESS WHEREOF, the parties hereto each herewith subscribe the same in duplicate.

CITY OF NORTHGLENN, COLORADO

By: _____
Joyce Downing Date

ATTEST:

Mayor
Title

Johanna Small, CMC Date
City Clerk

APPROVED AS TO FORM:

Corey Y. Hoffmann Date
City Attorney

CONSULTANT:

By: *[Signature]*

ATTEST:

ROBERT MATSU
Print Name

By: *William R. Misenhimer Jr.*
~~William R. AA~~

MANAGING MEMBER 7/21/2011
Title Date

WILLIAM R. MISENHIMER JR
Print Name

City's Contract # _____

ELECTRICAL DESIGNER 7/21/2011
Title Date

Name of City's Project Manager
Raymond Reling

EXHIBIT A

SCOPE OF SERVICES

To That Professional Service Agreement
Between the City of Northglenn (“City”) and
Integrated Solutions Engineering, LLC (“Consultant”)

A. Scope of Services – Consultant shall provide the City with electrical engineering and programming services for planned, unplanned and emergency projects related to the City’s Water Treatment Facility, Wastewater Treatment Facility, and other electrical appurtenance of the water distribution and sewer collection system. The Services may include, but are not limited to, Programmable Logic Controllers (PLC) programming, Supervisory Control and Data Acquisition (SCADA) system work, communication system repairs and upgrades, electrical wiring, and motor control center components.

Services provided by the Consultant shall not exceed thousand dollars (\$60,000.00) during the 2011 calendar year.

B. Authorization to Provide Services – The Consultant shall not be authorized to provide services to the City until the City approves a task order quote or authorizes the Consultant to complete an emergency task, as more fully described below:

1. Task Orders Tasks orders are intended to give the Consultant clear direction for a specific project and to give the City the total cost for the expected services provided by the Consultant. The process for approving task order will be as follows:

- a. The City will provide the Consultant with a written description of the work or services to be provided.
- b. The Consultant shall submit a not to exceed quote in response to the City’s project description. The Consultant’s quote shall include the estimated hours, billing rate, an itemized list of materials, expected duration, and the total cost to complete the task order.
- c. If accepted, the City will assign a task order number and provide the Consultant with written authorization to proceed.
- d. After the task is completed, the Consultant shall submit an invoice for payment in accordance with the terms and condition of the professional services agreement.
- e. If the task order can not be completed within the expected timeframe or under the authorized total cost, the task order may be amended at the City’s discretion.

2. Emergency Tasks Emergency tasks are defined as situations that require immediate action to for the safety of employees and/or restore service levels of the wastewater utility systems. The emergency task process will only be used in place of the task order process when for time sensitive projects. The following process will be used for emergency tasks:

- a. The City will verbally contact the Consultant and provide a description of the work or services to be provided.
- b. The Consultant shall provide the City with a verbal estimate of the total hours, an itemized list of materials, and expected duration to complete the emergency task. Each individual emergency task shall be limited to 10 billable hours unless otherwise approved by a City's for a longer duration.
- c. After the emergency task has been completed, the Consultant shall submit an invoice for payment in accordance with the terms and condition of the professional services agreement.

EXHIBIT B

SCHEDULE OF CHARGES

To That Professional Service Agreement
Between the City of Northglenn ("City") and
Integrated Solution Engineering, LLC ("Consultant")

The consultant's schedule charges for calendar year 2011 are as follows:

Labor Rates – Primary Service Provider

Normal Business Hours, 7 AM to 6 PM.....	\$130/hour
Outside of Normal Business Hours.....	\$175/hour

Labor Rates – Secondary Service Provider

Refer to the attached Service Pricing sheet for AmWest Control, Inc.

Expenses

All expenses such as copies and reproduction will be billed at cost.

Mileage

Mileage costs will accrue at the prevailing IRS rate.

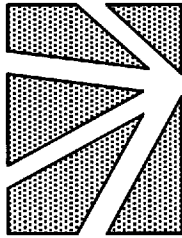

AmWest

Control, Inc.
10175 E. 106th Avenue
Brighton, CO 80601
Phone (303) 289-2115
FAX (303) 289-7701

Service Pricing

Rates Effective from 01/01/2011 through 12/31/2011

Item	Units	Cost
On-Call Service Work During Normal Working Hours- Technician	Hours	\$120/hour
On-Call Service Work During Normal Working Hours- Engineer/Programmer	Hours	\$135/hour
On-Call Service After Hours	Hours	\$180.00
On-Call Service Weekends	Hours	\$205.00
Scheduled Service Work- Technician	Hours	\$105/hour
Scheduled Service Work- Engineer/Programmer	Hours	\$120/hour
Engineering/Programming Services	Hours	\$120/hour
Drawing Revisions-CAD	Hours	\$70/hour

PROSPECTIVE CONSULTANT'S CERTIFICATE REGARDING EMPLOYING OR CONTRACTING WITH AN ILLEGAL ALIEN

FROM: INTEGRATED SOLUTIONS ENGINEERING
(Prospective Consultant)

TO: City of Northglenn
PO Box 330061
11701 Community Center Drive
Northglenn, CO 80233

Project Name _____

Bid Number _____ Project No. _____

As a prospective Consultant for the above-identified bid, I (we) do hereby certify that, as of the date of this certification, I (we) do not knowingly employ or contract with an illegal alien who will perform work under the Agreement and that I (we) will confirm the employment eligibility of all employees who are newly hired for employment to perform work under the Agreement through participation in either the E-Verify Program administered by the United States Department of Homeland Security and Social Security Administration or the Department Program administered by the Colorado Department of Labor and Employment.

Executed this 21 day of JULY, 2011.

Prospective Consultant INTEGRATED SOLUTIONS ENGINEERING

By: [Signature]

Title: MANAGING MEMBER

Finance Dept Use Only	
Initials	_____
Date	_____
PO #	_____

NO EMPLOYEE AFFIDAVIT

1. Check and complete one:

I, ROBERT MARTIN, am a sole proprietor doing business as INTEGRATED SOLUTIONS ENGINEERING. I do not currently employ any individuals. Should I employ any individuals during the term of my Agreement with the City, I certify that I will comply with the lawful presence verification requirements outlined in that Agreement.

OR

I, _____, am an owner/member/shareholder of _____, a _____ [specify type of entity-i.e, corporation, limited liability company], that does not currently employ any individuals. Should I employ any individuals during the term of my Agreement with the City, I certify that I will comply with the lawful presence verification requirements outlined in that Agreement.

2. Check one.

I, ROBERT MARTIN, am a United States citizen or legal permanent resident.

The City must verify this statement by reviewing one of the following items:

- o A valid Colorado Driver's license or a Colorado identification card*
- o A United States military card or a military dependent's identification card*
- o A United States Coast Guard Merchant Mariner card*
- o A Native American tribal document or*
- o In the case of a resident of another state, the driver's license or state-issued identification card from the state of residence, if that state requires the applicant to prove lawful presence prior to the issuance of the identification card*
- o Any other documents or combination of documents listed in the City's "Acceptable Documents for Lawful Presence Verification" chart that prove both the consultant's citizenship/lawful presence and identity.*

OR

I am otherwise lawfully present in the United States pursuant to federal law.

Consultant must verify this statement through the federal systematic alien verification of entitlement program, the "SAVE" program, and provide such verification to the City.

[Signature]
Signature

7/21/2011
Date

Finance Dept Use Only	
Initials	_____
Date	_____
PO #	_____