



**PARKS, RECREATION & CULTURAL SERVICES DEPARTMENT
MEMORANDUM #06-2018**

DATE: March 26, 2018
TO: Honorable Mayor Carol Dodge and City Council Members
FROM: James A. Hayes, AICP, City Manager 
Amanda J. Peterson, Director of Parks, Recreation and Culture 
SUBJECT: CR-49 – Croke Reservoir Pedestrian Bridge Abutment Construction & Bridge Installation Contract

PURPOSE

Staff is seeking approval of a contract with L&M Enterprises, Inc. for the construction of the abutments and installation of a pre-fabricated pedestrian bridge on the south side of Croke Reservoir.

BACKGROUND

The existing pedestrian bridge is located on the south side of Croke Reservoir near Kalamath Street and Naiad Drive. The bridge crosses over the Tuck Lateral, which allows residents direct access to the fishing pier, as well as to the soft surface walking trails that surround the reservoir. The existing bridge is approximately twenty-six years old and began settling several years ago. Parks staff have made temporary repairs over the last few years but the bridge is in need of a complete replacement, including new abutments to hold the new bridge in place and to prevent lateral movement of the new structure.

In late 2017 staff purchased premanufactured steel bridge from Contech Engineering Solutions, who also provided the design for the abutments that would be required for the installation of the bridge. Staff also published an Invitation for Bids (IFB) for the demolition and removal of the existing bridge, construction of the abutments and installation of the pedestrian bridge.

It was intended that this project be complete in 2017, within the allocated budget. However, as the abutments were engineered, it became apparent that the cost to place the bridge was going to be in excess of the identified budget, and would require a formal bid process. This bid process was initiated in late 2017.

Three formal bids were received on February 6, 2018 in response to the IFB issued for construction services. The proposals ranged in price from \$31,905.13 to \$54,833.00, as can be seen on the bid tab (Attachment A). The lowest bid was from J&M Enterprises, Inc. in the amount of \$31,905.13.

BUDGET/TIME IMPLICATIONS

This project has a total cost of \$60,883.76; inclusive of the work identified above, as well as expenses that have already been incurred, including the purchase of the bridge and the associated miscellaneous expenses as outlined in the table below. Funds were allocated in the 2017 Capital Project Fund from the Conservation Trust Fund (CTF) for the complete project in the amount of \$35,000, leaving a shortfall of \$25,885. In order to move forward with the replacement of the pedestrian bridge, a supplemental appropriation in the amount of \$25,885 will be required.

Soils Report (CTL Thompson, complete)	\$3,500.00
Pre-Manufactured Steel Bridge (Contech Engineering, complete)	\$22,000.00
Building Permit (SafeBuilt, complete)	\$288.12
Abutments/Installation (L&M Enterprises, contract for consideration)	\$31,905.13
Contingency (10% of L&M Enterprises contract, expended only if needed)	\$3,190.51
<hr/>	
Total Project Cost	\$60,833.76

Funds are available in the CTF unassigned fund balance to allow for the additional expenditure, which would be formally identified by supplemental appropriation in a separate action later in the year.

OPTIONS

Council options include:

1. Approve the agreement as presented and recommended by staff, which would require a supplemental appropriation in the amount of \$25,885, allowing the new bridge to be installed this spring.
2. Identify additional funds in the 2019 budget, and re-bid the project in 2019; storing the bridge until such time that it can be installed, with the risk that pricing may increase further and the existing bridge may become a more significant trip hazard as the year progresses.

NEXT STEPS

Attached to this memorandum is a resolution that, if approved, would:

1. Authorize the Mayor to execute a Professional Services Agreement between the City of Northglenn, Colorado and L&M Enterprises, Inc., for the **Croke Reservoir Pedestrian Bridge Abutment Construction & Bridge Installation**, with a contract amount of **\$31,905.13**.
2. Authorize a contingency of 10%, up to **\$3,190.51**.
3. Authorize the City Manager, on behalf of the City, to execute relevant change orders up to the approved expenditure limit of **\$35,095.64**.

Staff recommends approval of the proposed Resolution as presented.

STAFF REFERENCE

For additional information, please contact Amanda Peterson, Director of Parks, Recreation & Culture at apeterson@northglenn.org or 303.450.8950.

ATTACHMENTS

Attachment A Bid Tab

STAFF REFERENCE

Amanda Peterson, Director of Parks, Recreation & Culture
Dana Kester, Parks Project Coordinator

apeterson@northglenn.org
dkester@northglenn.org

ATTACHMENT A
Bid Tab



CITY OF NORTHGLENN
FORMAL BID SUMMARY

PAGE 1 of 1

BID NUMBER: IFB 2017-043
 BID NAME: Croke Reservoir Pedestrian Bridge Abutment
 Construction and Bridge Installation
 DEPARTMENT: Parks

	Goodland Construction INC.	Colt and Steel Corporation	Land M Enterprises INC.		
	BID RECEIVED	BID RECEIVED	BID RECEIVED	BID RECEIVED	BID RECEIVED
DATE DUE: 2/6/18	DATE: 2/5/18	DATE: 2/6/18	DATE: 2/6/18	DATE:	DATE:
TIME: 2:00 p.m. MST	TIME: 5:59 pm	TIME: 1:47 pm	TIME: 1:50 pm	TIME:	TIME:
Addendum One	yes	yes	yes		
Total for all Items	\$54,833.00	\$52,582.80	\$31,905.13		

Betsy Nohr
Finance Department

Shannon Fields
City's Clerk's Office

2/6/18
Date

SPONSORED BY: MAYOR DODGE

COUNCILMAN'S RESOLUTION

RESOLUTION NO.

No. CR-49
Series of 2018

Series of 2018

A RESOLUTION APPROVING AN AGREEMENT BETWEEN THE CITY OF NORTHGLENN AND L&M ENTERPRISES, INC. FOR THE CROKE RESERVOIR PEDESTRIAN BRIDGE ABUTMENT CONSTRUCTION AND BRIDGE INSTALLATION PROJECT

BE IT RESOLVED BY THE CITY COUNCIL OF THE CITY OF NORTHGLENN, COLORADO, THAT:

Section 1. The Trade Contractor Agreement between the City of Northglenn and L&M Enterprises, Inc., attached hereto, in the amount of \$31,905.13 with a ten percent (10%) contingency of \$3,190.51 for a total amount not to exceed \$35,095.64 for the Croke Reservoir Pedestrian Bridge Abutment Construction and Bridge Installation Project is hereby approved and the City Manager is authorized to execute same on behalf of the City of Northglenn.

DATED, at Northglenn, Colorado, this _____ day of _____, 2018.

CAROL A. DODGE
Mayor

ATTEST:

JOHANNA SMALL, CMC
City Clerk

APPROVED AS TO FORM:

COREY Y. HOFFMANN
City Attorney

TRADE CONTRACTOR AGREEMENT

TABLE OF CONTENTS

ARTICLE 1 - GENERAL PROVISIONS AND SERVICES..... 2

ARTICLE 2 - DEFINITIONS..... 2

ARTICLE 3 - DESCRIPTION OF WORK AND SERVICES..... 5

ARTICLE 4 – TRADE CONTRACTOR'S CONSTRUCTION SCHEDULE17

ARTICLE 5 - TIME FOR COMPLETION AND LIQUIDATED DAMAGES.....17

ARTICLE 6 - CONTRACT SUM.....19

ARTICLE 7 - CORRECTION OF WORK21

ARTICLE 8 - TEMPORARY FACILITIES AND SERVICES21

ARTICLE 9 - INDEMNIFICATION AND INSURANCE21

ARTICLE 10 - PERFORMANCE, LABOR AND MATERIAL PAYMENT BONDS24

ARTICLE 11 – CLAIMS AND DISPUTES.....24

ARTICLE 12 - RESOLUTION OF CLAIMS AND DISPUTES26

ARTICLE 13- TERMINATION.....27

ARTICLE 14 - SIMULTANEOUS WORK BY OTHERS28

ARTICLE 15 - SUBCONTRACTING.....29

ARTICLE 16 - GUARANTY30

ARTICLE 17 - SALES TAX30

ARTICLE 18 - MISCELLANEOUS PROVISIONS.....30

ARTICLE 19 - ATTACHMENTS, SCHEDULES AND SIGNATURES.....32

TRADE CONTRACTOR AGREEMENT

THIS AGREEMENT is made and entered into this ____ day of _____, 20____, by and between the City of Northglenn, State of Colorado, a Colorado home rule municipal corporation, hereinafter referred to as the "City" or "Owner" and L&M Enterprises, Inc., hereinafter referred to as the "Trade Contractor".

ARTICLE 1 - GENERAL PROVISIONS AND SERVICES

A. The Trade Contractor will commence and fully complete the construction of the Croke Reservoir Pedestrian Bridge Abutment Construction & Bridge Installation Project, which is described in **Exhibit A**, which is attached hereto and made a part hereof ("Project").

B. The Trade Contractor will furnish all of the material, supplies, tools, equipment, labor and other services necessary for the construction and completion of the project described herein.

C. The Trade Contractor will commence the work required by the contract documents within ten (10) calendar days after the date of the notification to proceed and will complete the same within twenty (20) day, unless the period for completion is extended otherwise by the contract documents. The Trade Contractor agrees to pay as liquidated damages, and not as a penalty, the sum of five hundred (\$500) for each consecutive calendar day's delay in completing this Contract after the completion dated specified herein, excluding any approved extensions of time because of unavoidable delay.

D. The Trade Contractor agrees to perform all of the work described in the contract documents and to comply with the terms therein for an amount not to exceed thirty one thousand nine hundred five dollars and 13/100 cents (\$31,905.13) as described in Article 5 of this Agreement.

ARTICLE 2 - DEFINITIONS

A. Wherever used in the contract documents, the following terms shall have the meanings indicated which shall be applicable to both the singular and plural thereof:

1. Addenda - Written or graphic instruments issued prior to the execution of the Agreement which modify or interpret the contract documents, drawings and specifications, by additions, deletions, clarifications or corrections.

2. Architect - The Architect shall be N/A

3. Bid - The offer or proposal of the bidder submitted in the prescribed form setting forth the prices for the work to be performed.

4. Bidder - Any person, firm or corporation submitting a bid for the work.

5. Bonds - Bid, performance and payment bonds and other instruments of security, furnished by the Trade Contractor and his surety in accordance with the contract documents.

6. Change Order - A written order to the Trade Contractor authorizing an addition, deletion or revision in the work within the general scope of the contract documents, or authorizing an adjustment in the contract price and/or contract time.

7. Contract Documents - The contract, including advertisement for bids, information for bidders, bid, bid bond agreement, bid schedule, labor and material, payment bond, performance bond, notice of award, notice to proceed, change order, general conditions, special conditions, general specifications, special specifications, scopes of work, addenda, drawings, schedules and any and all other documents or papers included or referred to in the foregoing documents are part of the Contract Documents
8. Contract Price - The total monies payable to the Trade Contractor under the terms and conditions of the contract documents.
9. Contract Time - The number of calendar days stated in the contract documents for the completion of the work.
10. Date of Award - Date of award of contract shall mean the date formal notice of such award, approved by the Owner, has been delivered to the intended awardee, or mailed to him at the main business address shown in his proposal by the Owner or it's authorized representative.
11. Day or Days - Unless herein otherwise expressly defined, "day" shall mean calendar day or days.
12. Drawings, Plans or Contract Documents - The part of the contract documents which shows the characteristics and scope of the work to be performed and which has been prepared or approved by the Engineer and/or Architect.
13. Engineer shall be Contech Engineering Solutions
14. Field Order - A written order effecting a change in the work not involving an adjustment in the contract price or an extension of the contract time, issued by the Engineer or the Owner to the Trade Contractor during construction.
15. Major Equipment or Major Equipment Items - Installation of major equipment to be furnished and placed under the contract awarded to the Trade Contractor and/or installations of major equipment to be furnished by the Owner and received, unloaded, stored, and placed under the contract awarded to the Trade Contractor.
16. Notice of Award - The written notice of the acceptance of the bid from the Owner to the successful bidder.
17. Notice to Proceed - Written communication issued by the Owner to the Trade Contractor authorizing him to proceed with the work and establishing the date of commencement of the work.
18. Owner or City - The City of Northglenn, Colorado, a home rule municipality. The Public Works Director of the Owner, or his designee, is the Owner's representative.
19. Project - Construction of the project described in **Exhibit A**.

20. Shop Drawings - All drawings, diagrams, illustrations, brochures, schedules, and other data which are prepared by the Trade Contractor, a subcontractor, manufacturer, supplier or distributor, which illustrate how specific portions of the work shall be fabricated or installed.

21. Site - The lands and other places on, under, in, or through which the work is to be executed or carried out and any other lands or places provided by the Owner for the purposes of the contract together with such other places as may be specifically designed in the contract documents as forming part of the site.

22. Special Conditions - Supplemental conditions that apply to specific aspects of the project or modifications to the general conditions that are to be adhered to in the project.

23. Subcontractor - An individual, firm or corporation having a direct contract with the Trade Contractor or with any other subcontractor for the performance of a part of the work at the site.

24. Substantial Completion - That date as certified by the Owner when the construction of the project or a specified part thereof is sufficiently completed, in accordance with the contract documents, so that the project or specified part can be utilized for the purposes for which it is intended.

25. Suppliers - Any person, supplier, or organization who supplies materials or equipment for the work, including that fabricated to a special design, but who does not perform labor at the site. A supplier is not a subcontractor who purchases an item of equipment from a manufacturer.

26. Trade Contractor - The person, firm or corporation with whom the City of Northglenn has executed this Agreement.

27. Work - All labor necessary to produce the construction required by the contract documents, and all materials and equipment incorporated or to be incorporated in the project. The work and the project are used interchangeably to mean the same thing.

28. Written Notice - Any notice to any party of the Agreement relative to any part of the Agreement in writing and considered delivered and the service thereof completed when posted by certified or registered mail to the said party at his last given address, or delivered in person to said party or his authorized representative on the work.

ARTICLE 3 - DESCRIPTION OF WORK AND SERVICES

Section 1. Drawings and Specifications.

- A. The intent of the drawings and specifications is that the Trade Contractor shall furnish all labor, materials, tools, equipment, and transportation necessary for the proper execution of the work in accordance with the contract documents and all incidental work necessary to complete the project in an acceptable manner, ready for use, occupancy or operation by the Owner.

B. Up to three (3) copies of the drawings and specifications will be furnished to the Trade Contractor without charge upon request, and any additional copies which the Trade Contractor may request will be furnished at the cost of reproduction. The drawings and specifications are to be used only in connection with the work specified herein and, with the exception of the signed contract set and As-Built drawings, are to be returned at the completion of the contract.

C. In case of conflict between the drawings and specifications, the drawings will govern. In case of conflict between the special specifications and the general specifications, the special specifications shall govern. Figure dimension on drawings will govern over scale dimensions, and detailed drawings will govern over general drawings. Notwithstanding the above, a document which is more restrictive or requires greater responsibility or increased compliance by the Trade Contractor shall govern.

D. Any discrepancies found between the drawings and specifications and site conditions or any inconsistencies or ambiguities in the drawings or specifications shall be immediately reported to the Owner, in writing, who will promptly resolve such inconsistencies or ambiguities in writing. Work done on unreported discrepancies, inconsistencies or ambiguities by the Trade Contractor shall be done at the Trade Contractor's risk.

E. The Trade Contractor may be furnished additional instructions and detail drawings, by the Owner, as necessary to carry out the work required by the contract documents. All additional instructions and detail drawings shall be issued to the Trade Contractor by the Owner.

F. The additional drawings and instructions thus supplied will become a part of the contract documents. The Trade Contractor shall carry out the work in accordance with the additional detail drawings and instructions.

Section 2. Materials, Services and Facilities.

A. It is understood that, except as otherwise specifically stated in the contract documents, the Trade Contractor shall provide and pay for all materials, labor, tools, equipment, water, light, power, transportation, supervision, temporary construction of any nature and all other services and facilities of any nature whatsoever necessary to execute, complete and deliver the work within the specified time.

B. In addition to the requirements for major equipment items previously given, within fourteen (14) days after execution of the Contract, the Trade Contractor shall submit to the Owner and Engineer a complete listing of the manufacturers of each item of equipment or assembly fabricated off the site which he proposed to furnish for the project, together with sufficient information, including shop assembly and detail drawings, manufacturers' specifications and performance data, to demonstrate clearly that the materials and equipment to be furnished comply with the provisions and intent of the contract documents. If the information shows any deviation from the Contract requirements, the Trade Contractor shall advise the Engineer and Owner of the deviation and state the reason for it in writing.

C. Only first class materials and materials which conform to the requirements of the specifications shall be incorporated in the work. All materials shall be new unless specified to be otherwise.

D. When requested by the Owner, the Trade Contractor shall furnish a written statement of the origin, composition, and manufacturer of any or all materials (manufactured, produced or grown) that are to be used in the work. The sources of supply of each material used will be approved by the Owner before delivery is started. If, at any time, sources previously approved, fail to produce materials acceptable to the Owner, the Trade Contractor shall furnish materials from other sources.

E. Materials and equipment shall be so stored as to insure the preservation of their quality and fitness for the work. Stored materials and equipment to be incorporated in the work shall be located so as to facilitate prompt inspection.

F. Manufactured articles, materials, and equipment shall be applied, installed, connected, erected, used, cleaned and conditioned as directed by the manufacturer.

G. Materials, supplies, and equipment shall be in accordance with samples submitted by the Trade Contractor and approved by the Engineer or Architect.

H. Materials, supplies or equipment to be incorporated into the work shall not be purchased by the Trade Contractor or the subcontractor subject to a chattel mortgage or under a conditional sale contract or other agreement by which an interest is retained by the seller.

I. The Trade Contractor shall retain, for the benefit of the Owner, all materials and supplies that are purchased for the project but are not used as a part of the project. The Owner may take any of the materials and supplies that are used in the project for any City purpose. Any materials and supplies not taken by the Owner shall be removed from the project site by the Trade Contractor.

Section 3. Shop Drawings.

A. The Trade Contractor shall submit shop drawings, samples and O&M manuals as may be necessary for the prosecution of the work as required by the contract documents on a timely basis so that the project schedule is not affected. The Engineer will promptly review all shop drawings. All such drawings will be approved and signed by the Engineer, and will be null and void unless authorized by such signature. The Engineer's approval of any shop drawing will not release the Trade Contractor from responsibility for deviations from the contract documents. The approval of any shop drawings which substantially deviates from the requirements of the contract documents shall be evidenced by a change order.

B. All drawings and details on items of major equipment will be reviewed by the Engineer only after the complete set of drawings and details covering the entire equipment package to be furnished under a particular major equipment item are submitted. Drawings submitted on a piecemeal basis covering only parts of the equipment package will be held for checking until the entire set of drawings are received.

C. The Trade Contractor shall also submit to the Engineer shop drawings showing all necessary detail for the proper installation of materials into the completed work, as provided by this Agreement.

D. The Trade Contractor shall make any indicated corrections on the drawings returned and shall resubmit corrected drawings until final approval is obtained.

E. The Trade Contractor shall have no claims for damages or extension of time on account of any delay in the work resulting from the rejection of material or from review, revision and resubmittal of drawings when the review, revision and resubmittal is due to changes to the original design documents, and other data for approval by the Engineer.

F. Each shop drawing shall be dated and shall be identified with the name of the project, the division, if any, the Contract item number, and the name of the Trade Contractor.

G. When submitted for the Engineer's review, shop drawings shall bear the Trade Contractor's certification that he has reviewed, checked and approved the shop drawings and that they are in conformance with the requirements of the contract documents.

H. The Trade Contractor shall submit the shop drawings in accordance with the general requirements.

I. Portions of the work requiring a shop drawing or sample submission shall not begin until the shop drawing or submission has been approved by the Engineer. A copy of each approved sample shall be kept in good order by the Trade Contractor at the site and shall be available to the Engineer.

J. By approving and submitting shop drawings and samples, the Trade Contractor thereby represents that he has determined and verified all field measurements, field construction criteria, materials, catalog numbers and similar data, or will do so, and that he has checked and coordinated each shop drawing and sample with the requirements of the work and of the contract documents.

Section 4. Records, Accounts and Audits.

A. The Trade Contractor agrees to keep one complete set of records and books of account on a recognized cost accounting basis (satisfactory to the Engineer), showing all expenditures, of whatever nature, made pursuant to the provisions of this Contract.

B. The Trade Contractor shall furnish the Engineer and Owner with such records, information and data as may be reasonable. The Engineer and Owner shall at all reasonable times be afforded the opportunity to inspect and/or audit the above-specified books and records of said Trade Contractor.

Section 5. Inspection and Testing.

A. All materials and equipment used in the construction of the project will be subject to adequate inspection and testing in accordance with generally accepted standards.

B. The Trade Contractor shall give sufficient advance notice of placing orders to permit tests to be completed before materials are incorporated in the work.

C. The Owner will provide all inspection and testing services required by the Contract Documents, unless specifically noted in the contract specifications for special inspection and testing services, such as, by way of example, welding inspections on off-site assembly.

D. Neither observations by the Engineer, and Owner, tests nor approvals by persons other than the Engineer and Owner will relieve the Trade Contractor from his obligations to perform the work in accordance with the requirements of the contract documents.

E. The Engineer, the Owner, and their representatives will at all times have access to the work and to locations where materials or equipment are being manufactured, stored, or prepared for use under these contract documents, and they shall have full facilities for unrestricted inspection of such materials, equipment, and work including full access to purchasing and engineering information, but not including prices, to the extent of uncovering, testing, or removing portions of the finished work. The Engineer and Owner shall be furnished with such information as may be required regarding materials used and the process of manufacture for the various items of equipment. Inspections by the Engineer and Owner of equipment or materials during its manufacture will be performed by or for the Owner solely in an effort to detect discrepancies and defects as early as possible, when they can be most readily corrected, and the work thereby expedited. No acceptance of equipment or materials will be construed to result from such shop inspections by the Engineer and Owner. Any inspections or tests or waivers thereof will not relieve the Trade Contractor of responsibility for meeting all requirements of these contract documents.

F. In addition, authorized representatives and agents of any participating federal or state agency shall be permitted to inspect all work, materials, payrolls, records of personnel, invoices of materials, and other relevant data and records. The Trade Contractor shall provide proper facilities for such access and observation of the work and also for any inspection or testing thereof.

G. In case of disputes between the Trade Contractor and the Engineer as to materials furnished or manner of performing the work, the Owner will have authority to reject materials or suspend the work until the question at issue can be decided by the Owner. The Owner is authorized to revoke, alter, enlarge, relax or release any requirements of these specifications, and to approve or accept any portion of the work, and to issue instructions contrary to the drawings and specifications.

Section 6. Construction Review

A. The Engineer will periodically observe the construction of all work covered by this Contract. The Engineer, on behalf of the Owner, shall be authorized to determine the amount or quantities of the several items of work which are to be paid for under this Contract; to order field changes within the scope of the Contract and to render decisions on any questions which may arise relative to the execution of the work covered by this Contract. The Engineer does not have authority to suspend work on the project. The Trade Contractor shall not suspend any portion of the work nor resume suspended work without the written authority of the Owner.

B. Neither Engineer's authority to act under the Contract nor any decision made by Engineer in good faith either to exercise or not exercise such authority shall give rise to any duty or responsibility of the Engineer to the Trade Contractor, any subcontractor, any supplier, or any other person or organization performing any of the Work, or to any surety for any of them.

C. Whenever in the drawings, plans or Contract Documents the terms "as ordered", "as directed", or the adjectives "reasonable", "suitable", "acceptable", "proper" or "satisfactory" or adjectives of like effect or import are used to describe a requirement, direction, review or judgment of Engineer as to the work, it is intended that such requirement, direction, review or judgment will be solely to evaluate the work for compliance with the contract documents. The use of any such

term or adjective shall not be effective to assign to Engineer any duty or authority to supervise or direct the furnishing or performance of the Work or any duty or authority to undertake responsibility for the project. Neither the Owner nor the Engineer will be responsible for the acts or omissions of Contractor or any Subcontractor, any Supplier, or of any other person or organization performing or furnishing any of the Work.

D. Periodic observation of the work in progress by the Engineer will be done whenever the Contractor is performing work that requires review as determined by the Engineer. The normal working time shall be during a regular 5-day, 40-hour work week, Monday through Friday. If the Trade Contractor elects to work more than 40 hours per week and observation is required during this overtime work as determined by the Engineer, the Engineer shall be paid by the Trade Contractor at the rate as specified herein for all review time required over the normal 5-day, 40-hour week. If the Engineer or his authorized representative is called to the job site to address problems created by the Trade Contractor, he will be paid by the Trade Contractor at the same rate as for overtime review as stated above. This payment shall be made by a credit to the Owner, and then the Engineer shall bill the Owner for the same.

E. If any work has been covered which the Engineer has not been specifically requested to observe prior to its being covered, or if the Engineer considers it necessary or advisable that covered work be inspected or tested by others, the Trade Contractor at the Engineer's request shall uncover, expose or otherwise make available for observation, inspection or testing as the Engineer may require, that portion of the work in question, furnishing all necessary labor, materials, tools and equipment. If it is found that such work is defective, the Trade Contractor shall bear all the expenses of such uncovering, exposure, observation, inspection and testing and of satisfactory reconstruction. If, however, such work is not found to be defective, the Trade Contractor will be allowed an increase in the contract price or an extension of the contract time, or both, directly attributable to such uncovering, exposure, observation, inspection, testing and reconstruction and an appropriate change order will be issued.

Section 7. Surveys, Permits and Regulations.

A. The Owner will furnish any existing land surveys in the Owner's possession. Provided however, the Trade Contractor shall perform all necessary land surveys to complete the work required by this Agreement. The Trade Contractor shall provide detailed construction staking.

B. At the beginning of the construction or as the work progresses, the Trade Contractor shall be responsible for the installation of property corners and the setting of bench marks.

C. Bench marks and survey stakes shall be preserved by the Trade Contractor and in case of their destruction, or removal by him, his employees, or others, they shall be replaced at the Trade Contractor's expense and his Sureties shall be liable therefor.

D. The Trade Contractor shall be responsible for elevations used in computing his bid.

E. The Trade Contractor shall secure and pay for all necessary permits, fees and licenses in connection with the performance of its work and shall pay all municipal and other governmental fees in connection therewith except those expressly provided by the specifications as being the responsibility of the Owner, and shall furnish at its expense any and all bonds and

cash or other deposits required by law or required by any lawful body having the right to make demand therefor.

F. The Owner will provide rights-of-way and permanent and temporary easements as shown on the plans for construction purposes. Any additional land actually needed by the Trade Contractor for the performance of the work, proper location of his plant and equipment, or the storage of materials and supplies for the work, shall be furnished by the Trade Contractor.

Section 8. Protection of Work, Property and Persons.

A. The Trade Contractor shall be responsible for initiating and maintaining all safety precautions and programs in connection with the work. Neither the Owner nor the Engineer will be responsible for Trade Contractor's means, methods, techniques, sequences or procedures of construction, or the safety precautions and programs incident thereto. The Trade Contractor shall take all necessary precautions for the safety of, and shall provide the necessary protection to prevent damage, injury or loss to all employees on the work who may be affected thereby, all the work and all materials or equipment to be incorporated therein, whether in storage on or off the site, and other property at the site or adjacent thereto, including trees, shrubs, lawns, walks, pavements, roadways, structures and utilities not designated for removal, relocation or replacement in the course of construction.

B. The Trade Contractor shall at all times consult with and obtain the approval of the Owner for the storage of material, operation of equipment, placing of temporary structures or dispositions of any surplus or waste materials upon property of the Owner anywhere outside the limits of construction. The Trade Contractor shall comply with all state, federal and local laws related to the storage or placement of any supplies, equipment, structures, or any other materials.

C. The Trade Contractor shall comply with all applicable laws, ordinances, rules, regulations and orders of any public body having jurisdiction. He shall erect and maintain, as required by the conditions and progress of the work, all necessary safeguards for safety and protection. He shall notify owners of adjacent utilities when prosecution of the work may affect them. The Trade Contractor shall remedy at his expense all damage, injury, or loss to any property or person caused, directly or indirectly, in whole or in part, by the Trade Contractor, any subcontractor or anyone directly or indirectly employed by any of them or anyone for whose acts any of them may be liable, except damage or loss attributable to the fault of the contract documents or to the acts or omissions of the Owner or the Engineer or anyone employed by either of them or anyone for whose acts either of them may be liable, and not attributable, directly or indirectly, in whole or in part, to the fault or negligence of the Trade Contractor. Notwithstanding the provisions of C.R.S. § 13-20-802.5(2), for purposes of this Contract, the measure of damages shall never be deemed to be the fair market value of the real property without an alleged construction defect.

D. The Trade Contractor shall observe all rules and regulations of the health department having jurisdiction and shall take precautions to avoid creating unsanitary conditions.

E. In emergencies affecting the safety of persons or the work or property at the site or adjacent thereto, the Trade Contractor, without special instruction or authorization from the Engineer or Owner, shall act to prevent threatened damage, injury or loss.

F. The Trade Contractor shall at all times conduct and work in such a manner as to

cause the least inconvenience and greatest protection to the general public. The Trade Contractor shall furnish and maintain barricades, warning signs, red flags, lights, and temporary passageways as may be necessary to protect the work and to safeguard the public. The cost of furnishing and maintaining the above facilities shall be incidental to the contract and no extra compensation for it will be allowed.

G. Throughout the performance of the work or in connection with this Contract, the Trade Contractor shall construct and adequately maintain suitable and safe crossings over trenches and such detours as are necessary to care for public and private traffic. The material excavated from trenches shall be compactly deposited along the sides of the trench or elsewhere in such a manner as shall give as little inconvenience as possible to the traveling public, to adjoining property owners, to other trade contractors, or to the City.

H. In performing the work, the Trade Contractor shall take the necessary action, including making arrangements with the owners or operators of existing power, cable and telephone lines, fiber-optic and telemetry lines, gas, water, sewer and other utilities or installations that may be encountered, whether privately or publicly owned, to prevent interference with the conditions, operations and maintenance of the respective utilities in a manner satisfactory to the owners, or operators of the respective utilities. Relocation or repair of utilities encountered even though not shown on the plans, shall be the responsibility of the Trade Contractor. The cost of the above measures, including maintaining of guards, watchmen, signals, barricades and temporary structures, making any necessary repairs and other cooperative or corrective work shall be borne by the Trade Contractor and shall be included in the prices bid in the Proposal for the related items of work. Neither the Owner nor the Engineer shall be responsible to the Contractor for the existence of utilities not shown on the plans or drawings and the Trade Contractor remains obligated under this paragraph for all hidden utilities.

I. The Trade Contractor shall be responsible for the preservation of all private or public property along and adjacent to the work and shall take all necessary precautions to prevent damage or injury thereto. Such preservation and protection shall include but not be limited to, trees, stone walls, fences, mail boxes, monuments, irrigation ditches, driveways, road access culverts, underground pipelines and structures. Such preservation and protection shall apply to all underground pipelines and utilities whether public, private or individually owned that are in or adjacent to the right-of-way. When direct or indirect damage is done to public or private property on account of the act, omission, neglect or misconduct in the prosecution or non-prosecution of the work on the part of the Trade Contractor, such property shall be restored by the Trade Contractor at the Trade Contractor's expense to a condition similar or equivalent to that which existed before such damage or injury was done, and brought up to current codes if applicable. The Trade Contractor shall be responsible for making all arrangements at his own expense for moving and operating equipment at temporary crossings of telephone and transmission lines, railroad tracks, irrigation ditches and pipelines.

Section 9. Communication with the Owner.

The Trade Contractor shall designate a responsible member of its organization at the site, whose duty shall be designated as the contact person for all communication between the Owner and the Trade Contractor. Said designated representative shall also be responsible to attend such meetings, as may be required to insure coordination and adequate performance of the work.

Section 10. Scope of Work.

The scope of work is described in the contract documents which are appended hereto and incorporated herein by this reference.

Section 11. Trade Contractor's Responsibility.

A. The Trade Contractor shall be responsible for all the work under this Contract until completion and final acceptance by the Owner.

B. The Trade Contractor shall supervise and direct the work. He shall be solely responsible for the means, methods, techniques, sequences and procedures of construction.

C. The Trade Contractor shall employ on the work only such persons who are competent and skilled in their assignments. Any employee who obstructs the progress of the work through incompetence or other means or conducts himself improperly shall be discharged or removed from the work when so requested by the Owner. This section shall not create a duty for the Owner to evaluate or assess the competence or skills of the Trade Contractors employees.

D. The Trade Contractor warrants that all materials and equipment furnished and incorporated by him in the project shall be new, unless otherwise specified, and that all work under this Trade Contract shall be of good quality, free from fault and defects and in conformity with the contract documents. All work not conforming to these standards shall be considered defective. The warranty provided herein shall be in addition to and not in limitation of any other warranty or remedy required by law or by the contract documents.

E. The Trade Contractor agrees that if he should fail or neglect to prosecute the work diligently and properly, or fail to perform any provisions of this Trade Contract, that the Owner, after three (3) days written notice to said Trade Contractor may, without prejudice to any other remedy, make good such deficiencies and may deduct the cost thereof from the payments then or thereafter due to the Trade Contractor pursuant to this Contract.

F. Tools furnished with any equipment may be used when approved by the Owner and shall be turned over to the Owner after completion of the work in a condition acceptable to the Owner. In case of rejection by the Owner, the Trade Contractor shall replace the tool or tools at no extra cost to the Owner.

G. Upon completion and before final acceptance of the work, the Trade Contractor shall remove from the site of the work and property of the Owner, all machinery, equipment, surplus materials, rubbish, barricades, signs and temporary structures and shall leave the premises in a condition which is satisfactory to the Owner.

H. The Trade Contractor shall keep one record set of the contract documents annotated to show all changes made during construction.

I. The Trade Contractor shall be responsible for the acts and omissions of all his employees and all subcontractors, their agents and employees and all other persons performing any of the work under a contract with the Trade Contractor.

J. Upon completion of the work, the Trade Contractor shall, at his or its expense, remove from the vicinity of the work, all plant, buildings, rubbish, unused materials, concrete forms

and other like material, belonging to him or used under his direction during construction, and in the event of his failure to do so, the same may be removed by the Owner and the Trade Contractor, his Surety or Sureties, shall be liable for the cost thereof. Also during the construction of the work, the site, partially finished structures, and material stockpiles shall be kept in a reasonable state of order and cleanliness.

Section 12. Changes in the Work.

A. CHANGES. Changes in the Work may be accomplished after execution of the Contract, and without invalidating the Contract, only by Change Order, Construction Change Directive, or Order for a Minor Change in the Work, subject to the limitations stated in this Article 7 and elsewhere in the Contract Documents.

1. A Change Order shall be based upon agreement among the Owner, Contractor, and Engineer; a Construction Change Directive requires agreement by the Owner and Engineer and may or may not be agreed to by the Contractor; an Order for a Minor Change in the Work may be issued by the Engineer alone.

2. Changes in the Work shall be performed under applicable provisions of the Contract Documents, and the Contractor shall proceed promptly, unless otherwise provided in the Change Order, Construction Change Directive, or Order for a Minor Change in the Work.

3. If unit prices are stated in the Contract Documents or subsequently agreed upon, and if the quantities originally contemplated are so changed in a proposed Change Order or Construction Change Directive that application of such unit prices to the quantities of work proposed will cause substantial inequity to the Owner or the Contractor, the applicable unit prices shall be equitably adjusted; provided however, that Owner may increase the number of units without change in the unit price if reasonable.

B. CHANGE ORDERS. The Contract Sum and the Contract Time may be changed only by Change Order. Methods used in determining adjustments to the Contract Sum may include those listed in Subsection C below. A Change Order is a written order to the Contractor, signed by the Contractor, the Owner and the Engineer, stating their agreement upon all of the following:

1. A change in the Work;
2. The amount of the adjustment in the Contract Sum, if any; and
3. The extent of the adjustment in the Contract Time, if any.

C. CONSTRUCTION CHANGE DIRECTIVES. A Construction Change Directive is a written order directed to the Contractor and signed by the Owner and Engineer, directing a change in the Work and stating a proposed basis for adjustment, if any, in the Contract Sum or Contract Time, or both. The Owner may by Construction Change Directive, without invalidating the Contract, order changes in the Work within the general scope of the Contract consisting of additions, deletions, or other revisions, the Contract Sum and Contract Time being adjusted accordingly.

1. A Construction Change Directive shall be used in the absence of total agreement on the terms of a Change Order.

2. If the Construction Change Directive provides for an adjustment to the Contract Sum, the adjustment shall be based on one of the following methods:

a. By mutual acceptance of a lump sum properly itemized and supported by sufficient substantiating data to permit evaluation;

b. By unit prices stated in the Contract Documents or subsequently agreed upon;

c. By cost to be determined in a manner agreed upon by the parties and a mutually acceptable fixed or percentage fee; or

d. By the method provided in Subparagraph (C)(3)(5).

3. Upon receipt of a Construction Change Directive, the Contractor shall promptly proceed with the change in the work involved and advise the Engineer and Owner of the Contractor's agreement or disagreement with the method, if any, provided in the Construction Change Directive for determining the proposed adjustment in the Contract Sum or Contract Time.

4. A Construction Change Directive signed by the Contractor indicates the agreement of the Contractor therewith, including adjustment in Contract Sum and Contract Time or the method for determining them. Such agreement shall be effective immediately and shall be recorded as a Change Order.

5. If the Contractor does not respond promptly to the Construction Change Directive or disagrees with the method for adjustment in the Contract Sum, the method and the adjustment shall be determined by the Engineer on the basis of reasonable expenditures and savings of those performing the work attributable to the change, including, in case of an increase in the Contract Sum, a percentage fee for overhead and profit not to exceed five percent (5%) of such work's actual cost for Contractor and ten percent (10%) of such work's actual cost to be apportioned between any and all subcontractors and sub-subcontractors. For work performed by Contractor's own forces, Contractor's mark-up shall be limited to actual cost plus a percentage fee for overhead and profit not to exceed ten percent (10%). In such case, the Contractor shall keep and present, in such form as the Engineer may prescribe, an itemized accounting of actual costs together with appropriate supporting data. For the purposes of this Subparagraph, actual costs shall be defined as and limited to the following:

a. Costs of labor, including Social Security, old age and unemployment insurance, fringe benefits required by agreement or custom, and workers' compensation insurance;

b. Costs of materials, supplies, and equipment, including costs of transportation, whether incorporated or consumed;

c. Reasonable rental costs of machinery and equipment, exclusive of hand tools, obtained and used specifically for such work, whether rented from the Contractor or others; and

d. Costs of premiums for all bonds (if any), permit fees, and sales, use or similar taxes directly attributable to such work. Actual cost does not include any item which could be deemed to be a general conditions cost or overhead, such as but not limited to, the cost of Contractor and Subcontractor supervisory personnel assigned to the Work, and field office and related expenses.

6. Pending final determination of actual cost to the Owner, amounts not in dispute may be included in applications for payment. The amount of credit to be allowed by the Contractor to the Owner for a deletion or change which results in a net decrease in the Contract Sum shall be actual net cost as confirmed by the Engineer. When both additions and credits covering related work or substitutions are involved in a change, the allowance for overhead and profit shall be figured on the basis of net increase, if any, with respect to that change.

7. If the Owner and Contractor do not agree with the adjustment in Contract Time or the method for determining it, the adjustment or the method shall be determined in accordance with Article 5 hereof.

8. When the adjustments in the Contract Sum and Contract Time are determined as provided herein, such determination shall be effective immediately and shall be recorded by preparation and execution of an appropriate Change Order.

D. MINOR CHANGES IN THE WORK

1. The Engineer will have authority to order minor changes in the Work not involving an adjustment in the Contract Sum or an extension of the Contract Time and not inconsistent with the intent of the Contract Documents. Such changes shall be effected by written order, and shall be binding on the Owner and the Contractor. The Contractor shall carry out such written orders promptly.

2. The Owner may at any time as the need arises, order changes within the scope of work without invalidating the Agreement. If such changes increase or decrease the amount due under the contract documents or in the time required for performance of the work, and equitable adjustment will be authorized by change order.

3. The Owner also may, at any time, by issuing a field order, make changes in the details of the work. The Trade Contractor shall proceed with the performance of any changes in the work so ordered by the Owner unless the Trade Contractor believes that such field order entitles him to a change in contract price or time, or both, in which event he shall give the Owner written notice thereof within ten (10) days after the receipt of the ordered change, and the Trade Contractor shall not execute such changes pending the receipt of an executed change order or further instruction from the Owner.

Section 14. Contract Documents.

In case of conflict between this Contract, the general conditions of the contract for construction, and the supplementary conditions, this Contract will govern.

ARTICLE 4 – TRADE CONTRACTOR'S CONSTRUCTION SCHEDULE

Section 1. Preconstruction Conference.

A preconstruction conference shall be scheduled at the time the Notice of Award is issued. The Trade Contractor, at the preconstruction conference, shall prepare and submit for the Owner's and the Engineer's review and approval a Trade Contractor's construction schedule for the Work, in such and form and detail as the Owner may require. The schedule shall not exceed time limits under the Contract Documents, shall be revised as required herein and at appropriate intervals as required by the conditions of the Work and Project, shall be related to the entire project to the extent required by the Contract Documents, and shall provide for the expeditious and practicable execution of the Work. The schedule shall indicate the proposed starting and completion dates for the various subdivisions of the Work as well as the totality of the Work. The schedule shall be updated every fourteen (14) days for submitted to Engineer with Trade Contractor's applications for payment. Each schedule shall contain a comparison of actual progress with the estimated progress for such time stated in the original schedule. If any schedule submitted sets forth a date for Substantial Completion for the Work or any phase of the Work beyond the date(s) of Substantial Completion established in the Contract (as the same may be extended as provided in the Contract Documents), the Trade Contractor shall submit to Engineer and Owner for their review and approval, a narrative description of the means and methods which Trade Contractor intends to employ to expedite the progress of the Work to ensure timely completion of the various phases of the Work as well as the totality of the Work. To ensure such timely completion, Trade Contractor shall take all necessary action including, without limitation, increasing the number of personnel and labor on the Project and implementing overtime and double shifts. In that event, Trade Contractor shall not be entitled to an adjustment in the Contract Sum or the Schedule.

Section 2. Schedule of Submittals.

The Contractor shall prepare and keep current, for the Engineer's approval, a schedule of submittals which is coordinated with the Contractor's construction schedule and allows the Engineer reasonable time to review submittals.

Section 3. Conformance to Schedule.

The Contractor shall conform to the most recent schedules.

ARTICLE 5 - TIME FOR COMPLETION AND LIQUIDATED DAMAGES

A. The date of beginning and the time for completion of the work are essential conditions of the contract documents and the work embraced shall be commenced on a date specified in the notice to proceed.

B. The Trade Contractor shall proceed with the work at such rate of progress to insure full completion within the Contract Time. It is expressly understood and agreed, by and between the Trade Contractor and the Owner, that the contract time for the completion of the work described herein is a reasonable time, If Trade Contractor is delayed in the progress of the Work by fire, unusual delay in transportation, unanticipated adverse weather conditions, or other unavoidable casualties beyond Trade Contractor's control other than unanticipated adverse weather conditions, the Contract Time shall be extended for a reasonable period of time. "Weather" means precipitation, temperature, or wind, and an "adverse weather condition" means

weather that on any calendar day varies from the average weather conditions for that day by more one hundred percent (100%) as measured by the National Oceanic and Atmospheric Administration. The term "unanticipated adverse weather conditions" means the number of days in excess of the anticipated adverse weather days per month as set forth below:

MONTHLY ANTICIPATED ADVERSE WEATHER DAYS

JAN	FEB	MAR	APR	MAY	JUN	JUL	AUG	SEP	OCT	NOV	DEC
7	4	4	4	6	3	4	2	3	3	2	5

By reason of example only, if in March there are two (2) days when the snowfall exceeds the average snowfall for that day by one hundred percent (100%), those two (2) days will have experienced an adverse weather condition. However, there will have been no unanticipated adverse weather condition in March, because there are four (4) anticipated adverse weather days in March, which should be accounted for in the schedule. If, however, there are five (5) days in which the snowfall exceeds the average snowfall by one hundred percent (100%), an unanticipated adverse weather condition will have occurred, and Trade Contractor shall be entitled to request an extension of time.

C. If the Trade Contractor shall fail to complete the work within the Contract Time, or extension of time granted by the Owner, then the Trade Contractor shall pay to the Owner the amount of liquidated damages and not as penalty the sum of five hundred (\$500) for each calendar day that the Trade Contractor shall be in default after the time stipulated in the contract documents.

D. The Owner will charge the Trade Contractor, and may deduct from the partial and final payment for the work, all architectural, engineering and construction management expenses incurred by the Owner in connection with any work accomplished after the specified completion date.

E. The Trade Contractor will not be charged with liquidated damages or any excess cost when the delay in completion of the work is due to the following, and the Trade Contractor has promptly given written notice of such delay to the Owner.

1. To any preference, priority or allocation order duly issued by the Owner.
2. To unforeseeable causes beyond the control and without the fault or negligence of the Trade Contractor, including, but not restricted to, unforeseen conditions, acts of God, or of the public enemy, acts of the Owner, fires, floods, epidemics, quarantine restrictions, strikes, freight embargoes, and abnormal and unforeseeable weather; and
3. To any delays of subcontractors occasioned by any of the causes specified in subparagraphs 1 and 2 of this paragraph E.

F. The Trade Contractor waives any right of recovery or reimbursement or by whatever name, as against the Owner or the Engineer, as a result of any delay or increase on overhead cost incurred by the Trade Contractor's association with any action or inaction on the part of any other trade contractor or supplier.

G. Any request for extension of the Contract Time shall be made in writing to the

Project Manager not more than seven (7) days after commencement of the delay; otherwise it shall be waived. Any such request shall contain an estimate of the probable effect of such delay on the progress of the Work.

H. In strict accordance with C.R.S. § 24-91-103.5, the City shall not amend the Contract Price to provide for additional compensation for any delays in performance which are not the result of acts or omissions of the City or persons acting on behalf of the City.

ARTICLE 6 - CONTRACT SUM

Section 1. Monthly or Progress Payments.

A. The City Council of the City of Northglenn has appropriated the money necessary to fund this project. The Owner shall pay the Trade Contractor in current funds for the performance of the work, subject to any additions and deletions, by written change order, the total sum not to exceed thirty one thousand nine hundred five dollars and 13/100 cents (\$31,905.13) (the "Original Contract Amount"). Notwithstanding anything to the contrary contained in this Agreement, no change order or other form of directive by the Owner requiring additional compensable work to be performed, which causes the aggregate amount payable under this Agreement, to exceed the amount appropriated for the Original Contract Amount, unless the Trade Contractor is given written assurance by the City of Northglenn that lawful appropriations have been made by the City Council of the City of Northglenn to cover the cost of the additional work.

B. The Engineer has, by separate agreement with the Owner, agreed to include in its monthly work estimate to the Owner, a review of the Trade Contractor's estimates of the value of all work, labor, and materials of the Trade Contractor incorporated into the Project. The Trade Contractor hereby agrees that estimates provided to the Engineer for review for the Owner shall be for work actually performed upon the project and that all such work, including labor and materials, have been paid. The determination of the amount of work completed on each application for payment by the Trade Contractor shall be made by the Engineer and shall thereafter be subject to approval by the Owner. Such determination, however, by the Engineer or approval by the Owner shall not be construed as acceptance of the work.

1. Before the first application for payment, the Trade Contractor shall submit to the Engineer and Owner a schedule of values to be allocated to the various portions of the Work, which in the aggregate equals the total Contract Sum, divided so as to facilitate payments to subcontractors, supported by such evidence of correctness as the Engineer may direct. This schedule, when approved by the Engineer, shall be used to monitor the progress of the Work and as a basis for making progress payments hereunder. Application for monthly progress payments shall be made in writing in accordance with this Contract and shall be submitted on approved forms provided by the Owner and shall be submitted to the Owner on or before the twentieth (20th) day of each month. Applications received on time will be paid on the twentieth (20th) day of the following month, providing that the Owner approves such recommendations of the Engineer. Applications received after the twentieth (20th) day of each month shall be paid after the Owner's next pay period.

2. Pursuant to Colo. Rev. Stat. § 24-91-103, as may be amended, where the Original Contract Amount exceeds one hundred fifty thousand dollars (\$150,000.00), the

Owner may retain up to five percent (5%) of the calculated value of completed work from each progress payment up until the contract is completed satisfactorily and finally accepted by the Owner. If the Owner finds satisfactory progress is being made in any phase of the contract, the Trade Contractor may make written request of the Owner for final payment of the withheld percentage. The Owner may agree to final payment of the withheld percentage if the Owner finds satisfactory and substantial reasons exist for the payment. The Trade Contractor must provide written approval to the Owner from any surety furnishing bonds for the contract work in order to receive said payment of the withheld percentage.

3. Upon receipt of written notice from the Trade Contractor that his work is ready for final inspection and acceptance by the Owner and upon receipt of final application for payment, the Owner will promptly make such final field review subject to the final payment requirements contained in Colo. Rev. Stat. § 38-26-107, as amended. If the Owner finds that the work is acceptable under the contract documents, he will recommend to the Owner that a final certificate of payment be issued. Neither final payment nor the remaining retention shall become due until the Trade Contractor submits to the Engineer an affidavit that all payrolls, bills for materials and equipment, and other indebtedness connected with the work, have been paid or otherwise satisfied. Likewise, final payment shall not be made until the consent of the surety to final payment has been obtained, and if required by the Owner, such other data establishing payment or satisfaction of all obligations, including releases, final lien waivers, and receipts and warranties, if any, have been provided to the Engineer for the use and benefit of the Owner. Should any subcontractor of the Trade Contractor or supplier of said Trade Contractor refuse to furnish any warranty and/or release or waiver, the Owner in its sole discretion, may refuse to certify final payment. The Trade Contractor may then furnish sufficient bonds satisfactory to the Owner to indemnify the Owner against any such liens.

4. Notwithstanding anything else to the contrary contained herein, such final payment by the Owner shall not be construed as a waiver of any claims affecting or arising from:

- a. Unsettled liens;
- b. Faulty or defective work appearing after substantial completion;
- c. Failure of the work to comply with the requirements of the contract documents;
- d. Terms of any special warranties required by the contract documents.

5. The acceptance by the Trade Contractor of final payment shall be and shall operate as a release to the Owner from all claims and all liability to the Trade Contractor for all things done or furnished in connection with this work and for every act and neglect of the Owner and others relating to or arising out of the work other than claims in stated amounts as may be specifically expected by the Trade Contractor with the consent of the Owner. Any payment, however, final or otherwise, will not release the Trade Contractor or his sureties from any obligations under the contract documents or the performance bond and labor and material payment bond.

ARTICLE 7 - CORRECTION OF WORK

A. During the life of the Contract and for a period of two (2) years after final acceptance, the Trade Contractor shall promptly remove from the premises all work rejected by the Owner for failure to comply with the contract documents, whether incorporated in the construction or not, and the Trade Contractor shall promptly replace and re-execute the work in accordance with the contract documents and without expense to the Owner and shall bear the expense of making good all work of other trade contractors destroyed or damaged by such removal or replacement. The Owner, however, may at its discretion elect to accept an equitable reduction in price or a refund instead of correction of the condemned work.

B. All removal and replacement work shall be done at the Trade Contractor's expense. If the Trade Contractor does not take action to remove such rejected work within ten (10) days after receipt of written notice, the Owner may remove such work and store the materials all at the expense of the Trade Contractor.

ARTICLE 8 - TEMPORARY FACILITIES AND SERVICES

Unless otherwise provided in this Contract, the Trade Contractor shall furnish and make available, at no cost, all temporary facilities, including all power needed for heating and protection of facilities and work. It is the expressed intent of the parties that the Trade Contractor shall be responsible for and at its sole cost all heating and protection of facilities and work.

ARTICLE 9 - INDEMNIFICATION AND INSURANCE

Section 1. Indemnification.

The Contractor, to the fullest extent permitted by law, shall defend, indemnify and hold harmless the City, its officers, employees, agents and their insurers, from and against all liability, claims and demands on account of injury, loss or damage, including without limitation, claims arising from bodily injury, personal injury, sickness, disease, death, property loss or damage or any other loss of any kind whatsoever, which arises out of or is in any manner connected with this Contract, to the extent that such injury, loss or damage is attributable to the act, omission, error, professional error, mistake, negligence or other fault of the Contractor, the Contractor's employees, subcontractors or anyone else employed directly or indirectly by the Contractor, Contractor's employees or subcontractor.

The Contractor, to the fullest extent permitted by law, shall defend, investigate, handle, respond and provide defense for and defend against any such liability, claims or demands at the sole expense of the Contractor, or at the option of the City, Contractor agrees to pay the City or reimburse the City for defense costs incurred by the City in connection with any such liability, claims, or demands. The Contractor, to the fullest extent permitted by law, shall defend and bear all other costs and expenses related thereto, including court costs and attorney fees, whether or not such liability, claims or demands alleged are groundless, false or fraudulent.

This indemnification provision is intended to comply with C.R.S. § 13-21-111.5(6), as amended, and shall be read as broadly as permitted to satisfy that intent.

Section 2. Insurance.

A. The Contractor agrees to obtain and maintain during the life of this Contract, a policy or policies of insurance against all liability, claims, demands and other obligations assumed by the Contractor pursuant to Section 1 above. Such insurance shall be in addition to any other insurance requirements imposed by this Contract or by law. The Contractor shall not be relieved of any liability, claims, demands, or other obligations assumed pursuant to Section 1 above, by reason of its failure to obtain and maintain during the life of this Contract insurance in sufficient amounts, durations, or types.

B. Contractor shall obtain and maintain during the life of this Contract, and shall cause any subcontractor to obtain and maintain during the life of this Contract, the minimum insurance coverages listed below. Such coverages shall be obtained and maintained with forms and insurers acceptable to the City. All coverages shall be continuously maintained to cover all liability, claims, demands and other obligations assumed by the Contractor pursuant to Section 1 above. In the case of any claims-made policy, the necessary retroactive dates and extended reporting periods shall be procured to maintain such continuous coverage.

1. Worker's Compensation Insurance to cover obligations imposed by applicable law for any employee engaged in the performance of the work under this Contract, and Employers Liability Insurance with minimum limits of five hundred thousand dollars (\$500,000) each incident, five hundred thousand dollars (\$500,000) disease—policy limit, and five hundred thousand dollars (\$500,000) disease—each employee.

2. General Public Liability Insurance to be written with a limit of liability of not less than one million dollars (\$1,000,000) for all damages arising out of bodily injury, personal injury (including coverage for employee and contractual acts), including death, at any time resulting therefrom, sustained by any one person and not less than two million dollars (\$2,000,000) for all damages arising out of bodily injury, including death, at any time resulting therefrom, sustained by two or more persons in any one accident. This policy shall also include coverage for blanket contractual and independent contractor risks. The limits of General Public Liability Insurance for broad form property damage (including products and completed operations) shall be not less than one million dollars (\$1,000,000) for all damages arising out of injury to or destruction of property in any one (1) accident and not less than two million dollars (\$2,000,000) for all damages arising out of injury to, or destruction of property, including the City's property, during the policy period. The General Public Liability Insurance policy shall include coverage for explosion, collapse and underground hazards. The policy shall contain a severability of interests provision.

3. Protective Liability and Property Damage insurance covering the liability of the Owner, including any employee, officer or agent of the Owner with respect to all operations under the Contract by the Trade Contractor or his sub-contractors shall be obtained and maintained during the life of the contract. The limits of the Owner's Protective Liability Policy, to be provided by the Trade Contractor, as described in this Section 2, shall be increased to the same limits as described above for the Trade Contractor's General Public Liability Insurance.

4. Comprehensive Automobile Liability Insurance with minimum combined single limits for bodily injury and property damage of not less than one million dollars

(\$1,000,000) each occurrence and one million dollars (\$1,000,000) aggregate with respect to each of the Trade Contractor's owned, hired, and non-owned vehicles assigned to or used in performance of the services. The policy shall contain a severability of interests provision. If the Trade Contractor has no owned automobiles, the requirements of this paragraph shall be met by each employee of the Trade Contractor providing services to the Owner under this contract.

C. To the extent that liability results from the acts or omissions of the Trade Contractor, all Insurance Policies and Certificates of Insurance issued for this project shall name as additional insured(s), the Owner, whether private or governmental, the Owner's officers and employees, and the Engineer and its agents and employees, and any other person(s), company(ies), or entity(ies) deemed necessary by the Owner. The Trade Contractor shall be solely responsible for any deductible losses under any policy required herein.

D. The insurance provided by the Trade Contractor shall be primary to insurance carried by the Owner, the Engineer, and all other additional insureds, and the principal defense of any claims resulting from the Trade Contractor's obligations under the Contract shall rest with the Trade Contractor's Insurer.

Section 3. Certificates of Insurance.

A. The certificate of insurance provided by the Trade Contractor shall be completed by the Trade Contractor's insurance agent as evidence that policies providing the required coverages, conditions, and minimum limits are in full force and effect, and shall be reviewed and approved by the Owner prior to commencement of the contract. No other form of certificate shall be used. The certificate shall identify this Contract and shall provide that the coverages afforded under the policies shall not be cancelled, terminated or materially changed until at least thirty (30) days prior written notice has been given to the Owner. The completed certificate of insurance shall be sent to:

Director of Public Works
City of Northglenn
11701 Community Center Drive
Northglenn, Colorado 80233-8061

B. Failure on the part of the Trade Contractor to procure or maintain policies providing the required coverages, conditions, and minimum limits shall constitute a material breach of contract upon which the Owner may immediately terminate this contract, or at its discretion the Owner may procure or renew any such policy or any extended reporting period thereto and may pay any and all premiums in connection therewith, and all monies so paid by the Owner shall be repaid by the Trade Contractor to the Owner upon demand, or the Owner may offset the cost of the premiums against any monies due to the Trade Contractor from the Owner.

C. The Owner reserves the right to request and receive a certified copy of any policy and any endorsement thereto.

D. The parties hereto understand and agree that the Owner is relying on, and does not waive or intend to waive by any provision of this contract, the monetary limitations (presently three hundred fifty thousand dollars (\$350,000) per person and nine hundred ninety thousand dollars (\$990,000) per occurrence) or any other rights, immunities, and protections provided by the Colorado Governmental Immunity Act, 24-10-114 et seq., C.R.S., as from time to time

amended, or otherwise available to the Owner, its officers or employees.

ARTICLE 10 - PERFORMANCE, LABOR AND MATERIAL PAYMENT BONDS

The Trade Contractor shall within ten (10) days after the receipt of a notice of award, furnish the Owner with a performance bond and a payment bond in penal sums equal to the amount of the contract price, conditioned upon the performance by the Trade Contractor of all undertakings, covenants, terms, conditions and agreements of the contract documents, and upon the prompt payment by the Trade Contractor to all persons supplying labor and materials in the prosecution of the work provided by the contract documents. Such bonds shall be executed by the Trade Contractor and a corporate bonding company licensed to transact such business in the state in which the work is to be performed and named on the current list of "Surety Companies Acceptable on Federal Bonds" as published in the Treasury Department Circular Number 570. The expense of these bonds shall be borne by the Trade Contractor. If at any time a surety on any such bond is declared a bankrupt or loses its right to do business in the state in which the work is to be performed or is removed from the list of Surety Companies accepted on Federal Bonds, the Trade Contractor shall within ten (10) days after notice from the Owner to do so, substitute an acceptable bond (or bonds) in such form and sum and signed by such other surety or sureties as may be satisfactory to the Owner. The premiums on such bond shall be paid by the Trade Contractor. No further payments will be deemed due nor shall be made until the new surety or sureties shall have furnished an acceptable bond to the Owner.

ARTICLE 11 – CLAIMS AND DISPUTES

A. Definition. A claim is a demand or assertion by one of the parties seeking, as a matter of right, adjustment of contract terms, payment of money, extension of time, or other relief with respect to the terms of the Contract. The term "claim" also includes other disputes between the Owner and Contractor arising out of or relating to the Contract. Claims must be made by written notice. The responsibility to substantiate claims shall rest with the party making the claim.

B. Decision of Engineer or Architect. Claims may, upon request of both the Contractor and the Owner, be referred initially to the Engineer or Architect for action as provided in Article 3, Section 12.

C. Time limits on Claims. Claims by either party must be made within twenty one (21) days after occurrence of the event giving rise to such claim or within twenty one (21) days after the claimant first recognizes, or reasonably should have recognized, the condition giving rise to the claim, whichever is later. An additional claim made after the initial claim has been implemented by change order will not be considered unless submitted in a timely manner.

D. Continuing Contract Performance. Pending final resolution of a claim, including litigation, unless otherwise directed by Owner in writing, the Contractor shall proceed diligently with performance of the Contract and the Owner shall continue to make payments in accordance with the Contract Documents.

E. Waiver of Claims: Final Payment. The making of Final Payment shall constitute a waiver of claims by the Owner except those arising from:

1. Liens, claims, security interests, or encumbrances arising out of the Contract and unsettled;

2. Failure of the Work to comply with the requirements of the Contract Documents;
3. Terms of special warranties required by the Contract Documents; or
4. Faulty or defective work appearing after Substantial Completion.

F. Claims for Concealed or Unknown Conditions. If conditions are encountered at the site which are (1) subsurface or otherwise concealed physical conditions which differ materially from those indicated in the Contract Documents or (2) unknown physical conditions of an unusual nature, which differ materially from those ordinarily found to exist and generally recognized as inherent in construction activities of the character provided for in the Contract Documents, then notice by the observing party shall be given to the other party promptly before conditions are disturbed and in no event later than seven (7) days after first observance of the conditions. Site conditions which an experienced and prudent contractor could have anticipated by visiting the site, familiarizing himself with the local conditions under which the Work is to be performed and correlating his observations with the requirements of the Contract Documents shall not be considered as claims for concealed or unknown conditions, nor shall the locations of utilities which differ from locations provided by the utility companies. The Engineer or Architect will promptly investigate such conditions and, if they differ materially and cause an increase or decrease in the Contractor's cost of, or the required time for, performance of any part of the Work, will recommend an equitable adjustment in the Contract Sum or Contract Time, or both. If the Engineer or Architect determines that the conditions at the site are not materially different from those indicated in the Contract Documents and that no change in the terms of the Contract is justified, the Engineer or Architect shall so notify the Owner and Contractor in writing, stating the reasons. Claims by either party in opposition to such determination must be made within twenty-one (21) days after the Engineer or Architect has given notice of the decision. If the Owner and Contractor cannot agree on an adjustment in the Contract Sum or Contract Time, the adjustment shall be referred to the Engineer or Architect for initial determination, subject to further proceeding pursuant to these Contract Documents.

G. Claims for Additional Cost. If the Contractor wishes to make claim for an increase in the Contract Sum, written notice as provided herein shall be given before proceeding to execute the work. Said notice shall itemize all claims and shall contain sufficient detail and substantiating data to permit evaluation of same by Owner and Engineer or Architect. No such claim shall be valid unless so made. Prior notice is not required for claims relating to an emergency endangering life or property. If the Contractor believes additional cost is involved for reasons including but not limited to (1) a written interpretation from the Engineer or Architect, (2) an order by the Owner to stop the Work where the Contractor was not at fault, (3) a written order for a minor change in the Work issued by the Engineer or Architect, (4) failure of payment by the Owner, (5) termination of the Contract by the Owner, (6) Owner's suspension, or (7) other reasonable grounds, claim shall be filed in accordance with the procedure established herein. Any change in the Contract Sum resulting from such claim shall be authorized by change order or construction change directive.

H. Claims for additional time. If the Contractor wishes to make claim for an increase in the Contract Time, written notice as provided herein shall be given. The Contractor's claim shall include an estimate of cost and of probable effect of delay on progress of the Work. In the case of a continuing delay, only one claim is necessary.

I. Injury or damage to person or property. Subject to the Parties' obligations and responsibilities under the Contract Documents in general and Article 8 hereof in particular, if either party to the Contract suffers injury or damage to person or property because of an act or omission

of the other party, of any of the other party's employees or agents, or of others for whose acts such party is legally liable, written notice of such injury or damage, whether or not insured, shall be given to the other party within a reasonable time not exceeding ten (10) days after first observance. The notice shall provide sufficient detail to enable the other party to investigate the matter. If a claim for additional cost or time related to this claim is to be asserted, it shall be filed as provided in Article 3, Section 12.

ARTICLE 12 - RESOLUTION OF CLAIMS AND DISPUTES

A. The Engineer (if the matter is referred to the Engineer for initial decision) will review claims and take one or more of the following preliminary actions within ten (10) days of receipt of a claim: (1) request additional supporting data from the claimant; (2) submit a schedule to the parties indicating when the Engineer expects to take action; (3) reject the claim in whole or in part, stating the reasons for rejection; (4) recommend approval of the claim by the other party; or (5) suggest a compromise. The Engineer may also, but is not obligated to, notify the surety, if any, of the nature and amount of the claim.

B. If a claim has been resolved, the Engineer (or at the Owner's option, Owner), will prepare or obtain appropriate documentation.

C. If a claim has not been resolved, the party making the claim shall within ten (10) days after the Engineer's preliminary response, take one or more of the following actions: (1) submit additional supporting data requested by the Engineer; (2) modify the initial claim; or (3) notify the Engineer that the initial claim stands.

D. If a claim has not been resolved after consideration of the foregoing and of further evidence presented by the parties or requested by the Engineer, the Engineer will notify the parties in writing that the Engineer's decision will be made within seven (7) days, which decision will be considered advisory only and not binding on the parties in the event of litigation in respect of the claim. Upon expiration of such time period, the Engineer will render to the parties the Engineer's written decision relative to the claim, including any change in the Contract Sum or Contract Time or both. If there is a surety and there appears to be a possibility of a Trade Contractor's default, the Engineer may, but is not obligated to, notify the surety and request the surety's assistance in resolving the controversy.

E. The dispute clause does not preclude the considerations of questions of fact or law in connection with decisions provided for in Paragraph A above. Nothing in this Agreement, however, shall be construed as making final a decision of an administrative official, representative or City Council on a question of fact or law.

F. As between the parties of this Agreement, as to all acts or failure to act by either party of this Agreement, any applicable statute of limitation shall commence to run from the date of the agreed party's discovery of such act or failure to act.

G. The Trade Contractor shall give written notice to the Owner within ten (10) days of any dispute/claim arising under this Contract upon which the Trade Contractor seeks compensation or change of contract documents, otherwise the Trade Contractor's dispute/claim shall be deemed waived. Said ten (10) days written notice shall not be deemed to run from the date of discovery in this instance but from the date the dispute/claim has arisen.

ARTICLE 13- TERMINATION

A. This Agreement may be terminated in whole or in part in writing by either party in the event of substantial failure by the other party to fulfill its obligations under this Agreement through no fault of the terminating party; provided that no such termination may be effected unless the other party is given (1) not less than ten (10) days written notice (delivered by certified mail, return receipt requested) of intent to terminate; and (2) an opportunity for consultation with the terminating party prior to termination.

B. This Agreement may be suspended or terminated in whole or in part, in writing, by the Owner for its convenience; provided that no such termination may be effected unless the Trade Contractor is given (1) not less than ten (10) days written notice (delivered by certified mail, return receipt requested) of intent to suspend or terminate; and (2) an opportunity for consultation with the Owner prior to suspension or termination.

C. Suspension for Convenience: The Owner, for its own convenience, may suspend the contract in whole or in part at any time by written notice to the Trade Contractor. Such notice shall state the extent and the effective date of such suspension, and on the effective date thereof the Trade Contractor shall promptly suspend such work to the extent specified, and during the period of such suspension shall properly care for and protect all work and materials, housing and equipment on hand for construction under the contract. The Trade Contractor also shall promptly supply the Owner with copies of all outstanding orders for materials, equipment and services, and shall take such action relative to such orders as may be directed by the Owner. If the performance of the work is thus suspended, the Trade Contractor shall be entitled to be reimbursed for all additional expense incurred by reason of such suspension as agreed upon by the Trade Contractor and the Owner.

D. Termination for Convenience:

1. The Owner may for its own convenience terminate work under the contract in whole or in part at any time by written notice to the Trade Contractor. Such notice shall state the extent and effective date of such termination and on the effective date thereof, the Trade Contractor will, and as to the extent directed, stop work under the contract and the placement of further orders of subcontracts under the contract, terminate work under order and subcontracts under the contract, and take any necessary action to protect property in the Trade Contractor's possession in which the Owner has or may acquire an interest.

2. In the event of such termination, the Owner shall pay to the Trade Contractor: (1) its direct costs (excluding overhead) for all work done in conformity with the Contract to the effective date of such termination and (2) other costs pertaining to the work which the Trade Contractor may incur as a result of such termination, all as approved by the Owner plus ten percent (10%) of such costs (excluding costs under (2) above) for overhead and profit, provided, however, that in no event shall the total amount to be paid under this Article 11, Section D.(2) plus payments previously made, exceed the lesser of (a) the total aggregate contract price specified in the Trade Contract; or (b) that proportion of the aggregate total contract price specified in the date of termination bears to the entire work to be performed hereunder. Any payment under this Article 11, Section D.(2) shall be made upon the expiration of the period within which liens may be filed under the laws of the state of Colorado, subject, however, to withholding by the Owner for the reasons and in the manner provided in those provisions pertaining to withholding of payments for

liens.

E. Termination for Default:

1. The Owner shall have the right to terminate the employment of the Trade Contractor after giving ten (10) days written notice of the termination to the Trade Contractor in the event of any default by the Trade Contractor. In the event of such termination, the Owner may take possession of the work and of all materials, tools and equipment thereon and may finish the work by whatever method and means he may select. It shall be considered a default by the Trade Contractor whenever he shall:

a. Disregard or violate important provisions of the contract documents or the Owner's instructions, or fail to prosecute the work according to the agreement schedule of completion, including extensions thereof;

b. Fail to provide a qualified representative, competent workmen or subcontractors, or proper materials, or fail to make prompt payment therefor; and

c. Fail to submit a completion schedule within fourteen (14) days after award of contract.

2. Upon termination of the contract by the Owner for default by the Trade Contractor, no further payments shall be due to the Trade Contractor until the work is completed. If the unpaid balance of the contract amount shall exceed the cost of completing the work including all overhead costs, the excess shall be paid to the Trade Contractor. If the cost of completing the work shall exceed the unpaid balance, the Trade Contractor shall pay the difference to the Owner. The amount of the cost incurred by the Owner in implementing the work, and the damage incurred through the Trade Contractor's default, shall be approved by the Owner.

3. The provisions of this Article 11, Section D.(2) shall not apply in the event of default of the Trade Contractor; provided, however, that the provisions of Article 11, Section D.(2) shall apply in the event of substantial failure by the Owner to fulfill its obligations under this Agreement.

ARTICLE 14 - SIMULTANEOUS WORK BY OTHERS

A. The Owner reserves the right to let other contracts in connection with this project. The Trade Contractor shall afford other trade contractors reasonable opportunity for the introduction and storage of their materials and the execution of their work, and shall properly connect and coordinate his work with theirs.

B. If the proper execution or results of any part of the Trade Contractor's work depends upon the work of any other trade contractor, the Trade Contractor shall inspect and promptly report to the Engineer any defects in such work that render it unsuitable for such proper execution and results. Failure of the Trade Contractor to so inspect and report defects shall constitute an acceptance of the other trade contractors' work as fit and proper for the addition of his work thereto, except as to defects which may develop in the other trade contractors' work after the execution of his work.

C. The Trade Contractor shall coordinate his operations with those of other trade contractors. Cooperation will be required in the arrangement for the storage of materials and in

the detailed execution of the work.

D. The Trade Contractor, including his subcontractors, shall keep informed of the progress and the detail work of other trade contractors and shall notify the Engineer immediately of lack of progress, defective workmanship, or lack of coordination on the part of other trade contractors. Failure of the Trade Contractor to keep informed of the work progressing on the site and failure to give notice of lack of progress, defective workmanship, or lack of coordination by others shall be construed as acceptance by him of the work and the status of work as being satisfactory for proper execution of his own work.

E. All materials and labor shall be furnished at such times as shall be for the best interest of all trade contractors concerned, to the end that the combined work of all may be properly and fully completed on contract time.

F. Nothing herein shall be construed in any way as giving the Trade Contractor a claim as against the Owner and the Engineer resulting in any revised schedule based upon delay caused by any other trade contractor or supplier.

ARTICLE 15 - SUBCONTRACTING

A. The Trade Contractor may utilize the services of specialty subcontractors on those parts of the work which, under normal contracting practices, are performed by specialty subcontractors.

B. Before execution of the contract, the Trade Contractor shall submit the names of all subcontractors, including contact persons, phone numbers, and addresses to the Engineer or Architect and Owner. The Trade Contractor shall also promptly notify all parties of any changes in subcontractors or subcontractor contact information.

C. The Trade Contractor shall be fully responsible to the Owner for the acts and omissions of his subcontractors, and of persons either directly or indirectly employed by them, as he is for the acts and omissions of persons directly employed by him.

D. The Trade Contractor shall cause appropriate provisions to be inserted in all subcontracts relative to the work to bind subcontractors to the Trade Contractor by the terms of the contract documents insofar as applicable to the work of subcontractors and to give the Trade Contractor the same power as regards terminating any subcontract that the Owner may exercise over the Trade Contractor under any provision of the contract documents.

E. Nothing contained in this Contract will create any contractual relation between any subcontractor and the Owner.

ARTICLE 16 - GUARANTY

A. The Trade Contractor shall guarantee all materials and equipment furnished and work performed for a period of two (2) years from the date of final acceptance of the contract by the Owner that the work is free from all defects due to faulty materials or workmanship and that the Trade Contractor shall promptly make such corrections as may be necessary by reason of such defects including the repairs of any damage to other parts of the system resulting from such defects. The Owner will give notice of observed defects with reasonable promptness. In the event that the Trade Contractor should fail to make such repairs, adjustments, or other work that may be made necessary by such defects, the Owner may do so and charge the Trade Contractor the cost thereby incurred. The performance bond shall remain in full force and effect through the guarantee period.

B. Whenever in the specifications a guarantee or maintenance bond is required to be furnished for any item of equipment, material or portion of the work, such guarantee shall be submitted to the Owner and a written approval will be issued to the Trade Contractor before any such equipment, material or construction is ordered and incorporated in work by the Trade Contractor.

ARTICLE 17 - SALES TAX

The Trade Contractor and all of his subcontractors must make application to the Colorado State Department of Revenue for a certificate of exemption to permit the purchase of building materials for the construction of this project without payment of the sales tax. Prior to the start of construction, the Trade Contractor shall furnish copies of such certificates to the Owner. Applications and certificates must be on forms provided by the Department of Revenue.

ARTICLE 18 - MISCELLANEOUS PROVISIONS

A. This Agreement is made and entered into subject and conformable to the laws of the State of Colorado and the Home Rule Charter of the City of Northglenn. To the extent any provision hereof is inconsistent with said laws and Charter, said laws and Charter shall control.

B. The Trade Contractor shall comply with all federal and state laws and local ordinances and regulations which affect those engaged or employed in the work or which affect the conduct of the work, and of all such orders and decrees of bodies or tribunals having any jurisdiction or authority over the same, and shall at all times observe and comply with all such existing laws, ordinances, regulations and decrees, and shall protect and indemnify the Owner and the Engineer against any claim or liabilities arising solely from or based solely on the violations of such law, ordinance, regulation, order or decree, whether by itself, its subconsultants, agents, or employees.

C. The Trade Contractor will take affirmative action to not discriminate against any employee or applicant for employment because of race, creed, color, national origin, sex or handicap, if otherwise qualified.

D. In the event any provision of this Agreement is held invalid and unenforceable, the remaining provisions shall be valid and binding upon the parties.

E. One or more waivers by either party of any provision, term, condition or covenant

shall not be construed by the other party as a waiver of a subsequent breach of the same by the other party.

F. The Owner and the Trade Contractor each binds itself and its partners, successors, executors, administrators, and assigns to this Agreement. Neither the Owner nor the Trade Contractor will assign, sublet, or transfer its interest in this Agreement without the written consent of the other.

G. Nothing herein shall be construed as creating any personal liability on the part of any officer or agent of any public body which may be a party hereto, nor shall it be construed as giving any rights or benefits hereunder to anyone other than the Owner and the Trade Contractor.

H. Illegal Aliens.

1. Certification. By entering into this Agreement, Contractor hereby certifies that, at the time of this certification, it does not knowingly employ or contract with an illegal alien who will perform work under the Agreement and that Contractor will participate in either the E-Verify Program administered by the United States Department of Homeland Security and Social Security Administration or the Department Program administered by the Colorado Department of Labor and Employment in order to confirm the employment eligibility of all employees who are newly hired for employment to perform work under the Agreement.

2. Prohibited Acts. Contractor shall not:

a. Knowingly employ or contract with an illegal alien to perform work under this Agreement; or

b. Enter into a contract with a subcontractor that fails to certify to Contractor that the subcontractor shall not knowingly employ or contract with an illegal alien to perform work under this Agreement.

3. Verification.

a. Contractor has confirmed the employment eligibility of all employees who are newly hired for employment to perform work under this Agreement through participation in either the E-Verify Program or the Department Program.

b. Contractor shall not use the E-Verify Program or the Department Program procedures to undertake pre-employment screening of job applicants while this Agreement is being performed.

c. If Contractor obtains actual knowledge that a subcontractor performing work under this Agreement knowingly employs or contracts with an illegal alien who is performing work under the Agreement, Contractor shall:

i. Notify the subcontractor and the City within three (3) days that Contractor has actual knowledge that the subcontractor is employing or contracting with an illegal alien who is performing work under the Agreement; and

ii. Terminate the subcontract with the subcontractor if within three (3) days of receiving the notice required pursuant to subparagraph (a) hereof, the subcontractor does not stop employing or contracting with the illegal alien who is performing work under the Agreement; except that Contractor shall not terminate the contract with the subcontractor if during such three (3) days the subcontractor provides information to establish that the subcontractor has not knowingly employed or contracted with an illegal alien who is performing work under the Agreement.

4. Duty to Comply with Investigations. Contractor shall comply with any reasonable request by the Colorado Department of Labor and Employment made in the course of an investigation conducted pursuant to C.R.S. § 8-17.5-102(5)(a) to ensure that Contractor is complying with the terms of this Agreement.

5. If Contractor does not currently employ any employees, Contractor shall sign the No Employee Affidavit attached hereto.

6. If Contractor wishes to verify the lawful presence of newly hired employees who perform work under the Agreement via the Department Program, Contractor shall sign the Department Program Affidavit attached hereto.

I. Keep Jobs in Colorado Act: Pursuant to the Keep Jobs in Colorado Act, C.R.S. 8-17-101 *et seq.* (the "Act") and the rules adopted by the Division of Labor of the Colorado Department of Labor and Employment implementing the Act (the "Rules"), the Contractor shall employ Colorado labor to perform at least eighty percent (80%) of the work and shall obtain and maintain the records required by the Act and the Rules. For purposes of this Section "Colorado labor" means any person who is a resident of the state of Colorado at the time of this Project, without discrimination as to race, color, creed, sex, sexual orientation, marital status, national origin, ancestry, age, or religion except when sex or age is a bona fide qualification. A resident of the state is a person who can provide a valid Colorado driver's license, a valid Colorado state-issued photo identification, or documentation that he or she has resided in Colorado for the last thirty (30) days. Contractor represents that it is familiar with the requirements of the Act and the Rules and will fully comply with same. This Section shall not apply to any project for which appropriation or expenditure of moneys may be reasonably expected not to exceed five hundred thousand dollars (\$500,000) in the aggregate for any fiscal year.

ARTICLE 19 - ATTACHMENTS, SCHEDULES AND SIGNATURES

It is further mutually agreed that this Agreement and the contract documents constitute the entire Agreement between the Owner and the Trade Contractor and supersede all prior or oral understandings. This Agreement may only be amended, supplemented, modified, or cancelled by a duly executed written amendment.

IN WITNESS WHEREOF the parties hereto each herewith subscribe the same in triplicate.

CITY OF NORTHGLENN, COLORADO

By: _____

Name: James A. Hayes, AICP

Title: City Manager

ATTEST:

Johanna Small, CMC, City Clerk

APPROVED AS TO FORM:

Corey Y. Hoffmann, City Attorney

TRADE CONTRACTOR

By: _____

Name: Justus Bebo

Title: President

STATE OF COLORADO)
) ss.
COUNTY OF Larimer)

The foregoing instrument was acknowledged before me this 16 day of February, 2018 by Justus Bebo, as President of Land M Enterprises, Inc.

My commission expires: 01-05-2019

Witness my hand and official seal.

Donna Bradshaw
Notary Public

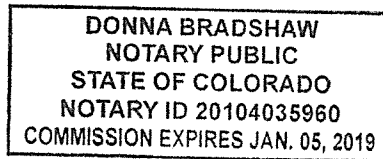

PROSPECTIVE CONTRACTOR'S CERTIFICATE REGARDING EMPLOYING OR CONTRACTING WITH AN ILLEGAL ALIEN

FROM: Land M Enterprises, Inc.
(Prospective Contractor)

TO: City of Northglenn
11701 Community Center Drive
Northglenn, Colorado 80233-8061

Project Name Croke Reservoir Pedestrian Bridge

Bid Number 2017-043

Project No. 2018-019

As a prospective Contractor for the above-identified bid, I (we) do hereby certify that, as of the date of this certification, I (we) do not knowingly employ or contract with an illegal alien who will perform work under the Agreement and that I (we) will confirm the employment eligibility of all employees who are newly hired for employment to perform work under the Agreement through participation in either the E-Verify Program administered by the United States Department of Homeland Security and Social Security Administration or the Department Program administered by the Colorado Department of Labor and Employment.

Executed this 16 day of February, 2018

Prospective Contractor Land M Enterprises, Inc.

By: [Signature]

Title: President

BID SUMMARY

L and M Enterprises, Inc

(Vendor Name)

Hereby submits to the City of Northglenn, Colorado the following bid items complete and in place as specified for the:

Croke Reservoir Pedestrian Bridge Abutment Construction and Bridge Installation - IFB 2017-043

ITEM DESCRIPTION	UNIT	ESTIMATED QUANTITY	UNIT COST	TOTAL COST
Demo/Sawcut/Removal	LS	1	1,615.39	1,615.39
Clearing,Erosion/Sediment Cont	LS	1	807.69	807.69
Excavation &Site Prep	LS	1	8,320.51	8,320.51
Construction of abutments	LS	1	14,253.85	14,253.85
Set & Install Bridge	LS	1	6,907.69	6,907.69

TOTAL FOR ALL ITEMS 31,905.13

TOTAL IN WORDS thirty one thousand nine hundred five dollars and thirteen cents

SECTION 013500 – SPECIAL CONDITIONS

PART 1 - GENERAL

1.1 PROJECT DESCRIPTION

The Contractor shall furnish all material, labor, equipment and services necessary for, and incidental to, the Croke Reservoir Pedestrian Bridge Abutment Construction and Bridge Installation project, as specified herein. The project includes the demolition and removal of an existing pedestrian bridge in the specified location, construction of new abutments, and installation of a new pre-fabrication pedestrian bridge.

1.2 LOCATION OF WORK

- A. The work is located north of Naiad Dr and Kalamath St within the City of Northglenn's City Limits. Refer to the Pedestrian Bridge Site Map (**Attachment 1**) included in the IFB documents. Prospective bidders should make themselves familiar with the location of the work and all potential access points so as to facilitate progress of the work in a well-organized fashion.

1.3 TIME OF WORK

- A. The Contractor shall complete all work required by these specifications within thirty (30) calendar days. The starting time for the Contract shall be ten (10) calendar days following the date of the Notice to Proceed as defined in Section 6.01 of the General Conditions. Working hours shall be 7:00 A.M. to 5:00 P.M. Monday through Friday. A working day shall be defined as any day, exclusive of Saturdays, Sundays and holidays, on which weather and other conditions not under the control of the Contractor will permit construction to proceed for a minimum of one half (1/2) of the day with a normal working force.

The Contractor shall be responsible for submitting a schedule for all work to be performed. This schedule shall be updated weekly and resubmitted to the Engineer for acceptance.

1.4 PROTECTION OF EXISTING UTILITIES

- A. The Contractor shall be responsible for the protection of existing utilities such as water mains, sewer systems, gas mains, electrical conduits, telephone lines, irrigation systems and any other utilities within the area; and if any damage or destruction occurs to these utilities, the Contractor shall be responsible for their repair and/or replacement at the Contractors expense.

1.5 QUALITY ASSURANCE

- A. Referenced Standards:
 - 1. City of Northglenn, Street and Drainage Standards and Specifications (latest addition). The Public Right-of-Way Standards and Specifications are available on the city of Northglenn website.
- B. In the event of a conflict occurring between or within the aforementioned Standards and Specifications, the more stringent standard will apply, which may arise. The Contractor shall coordinate inspection of the work by various City staff and private testing agencies. Any discrepancies found between the Drawings and Specifications and site conditions or any errors or omissions in the Drawings or Specifications shall be immediately reported in writing to the Project Manager, who shall promptly correct such errors, or omissions in writing. Any work done by the Contractor after his discovery of such discrepancies, errors or omissions WITHOUT written instructions by the Project Manager shall be done at the Contractor's risk.

1.6 LIQUIDATED DAMAGES

- A. Liquidated damages as detailed in Section 7.03 of the General Conditions shall be set at \$2,000.00 per day. This charge for liquidated damages will be in addition to other penalties set forth in the Contract.

1.7 SPECIAL CONSIDERATIONS

- A. Contractor shall be responsible for negotiations of any waivers or alternate arrangements required to enable transportation of materials to the site.

1.8 SPECIAL CONTRACT PROVISION

- A. The items listed in the Bid Summary are estimated for comparison purposes only. The City of Northglenn reserves the right to increase or decrease items at the unit cost to insure completion of the work within the approved budget.

1.9 CONTRACT DOCUMENTS FOR CONTRACTORS USE

- A. Refer to General Conditions.
- B. Contractor shall pick up two "no-charge" documents within 10 days from date of Notice to Proceed.

1.10 ORDER OF CONSTRUCTION AND CONSTRUCTION SCHEDULE

- A. Construction operations will be scheduled to allow the Owner uninterrupted operation of existing adjacent facilities. Coordinate connections with existing work to ensure timely completion of interfaced items.
- B. At no time shall Contractor or his employees modify operation of the existing facilities or start construction modifications without approval of the Owner except in emergency to prevent or minimize damage.
- C. If Contractor does not take necessary action to accomplish work according to schedule, he may be ordered by Owner in writing to take necessary and timely action to improve work progress. Order may require increased work forces, extra equipment, extra shifts or other action as necessary. Should Contractor refuse or neglect to take such action authorized, under provisions of this contract, Owner may take necessary actions including, but not necessarily limited to, withholding of payment and termination of contract.

1.11 PERMITS

- A. Contractor is responsible for securing all permits from the City of Northglenn as required by Ordinance. All City of Northglenn Permit fees will be waived by the City. The required building permit for the bridge has already been obtained by the City.

1.12 SAFETY AND HEALTH REGULATIONS FOR CONSTRUCTION

- A. These construction documents are to be governed, at all times, by applicable provisions of the Federal Law(s), including but not limited to the latest amendment of the following:
 - 1. Williams-Steiger Occupational Safety and Health Act of 1970, Public Law 94-596.

2. Part 1910-Occupational Safety and Health Standards, Chapter XVII of Title 29, Code of Federal Regulations.
3. Part 1926-Safety and Health Regulations for Construction, Chapter XVII of Title 29, Code of Federal Regulations.
4. Part II Department of Labor Occupational Safety and Health Administration 29CFR Part 1926 Occupational Safety and Health Standards - Excavations; Final Rule.

B. Sanitary Facilities: Provide temporary toilets, wash facilities, and drinking water for use of construction personnel. Comply with authorities having jurisdiction for type, number, location, operation, and maintenance of fixtures and facilities.

1.13 PRECONSTRUCTION CONFERENCE

A. A pre-construction conference shall be held at the Owner's office after award of Contract. Engineer will notify the Contractor as to the date and time of the conference 2 weeks in advance of the proposed date. Contractor's Project Manager and Project Superintendent and Contractor's Subcontractor Representatives shall attend. The Contractor should be prepared to discuss a detailed plan for construction of the project at the meeting.

1.14 PROGRESS MEETING

A. As needed, the Owner will conduct construction meetings involving:

1. Contractor's project manager
2. Contractor's project superintendent
3. Owner's designated representative(s).
4. Contractor's subcontractors as appropriate to the work in progress.

1.15 CHANGE MODIFICATION PROCEDURES

- A. Request for Information (RFI's)
1. Contractor shall request clarification of contract documents by issuing a Request for Information to the RPR. Contractor shall afford at least 48 hours for Engineer's response. RFIs will be issued on the Contractor's form containing the following minimum information: RFI number, date, project name, Owner, specification section number, drawing number, explanation of request, name and title of person submitting request, date response is required by, clear space for Engineer's response and signature.
- B. Field Orders:
1. Field Orders will be issued by the Resident Project Representative (RPR) directing prompt minor changes in work that do not change the contract sum and/or time. If Contractor believes that a change in contract sum and/or time is required, they shall submit an itemized proposal including labor, equipment and material costs and additional time to the RPR immediately and before beginning work. If the proposal is acceptable, a Change Order will supersede the Field Order.
- C. Change Proposal Request (CPR):
1. Change Proposal Requests will be issued for work items that will change the contract sum and/or time. CPRs are a negotiating instrument, not a contractual change order. CPRs must be accompanied by an itemized proposal, including labor, equipment and material costs, and request for additional time. CPRs must be submitted to the RPR allowing sufficient time for negotiations without impact to the construction schedule.
- D. Change Order:

1. Change Orders will serve to amend the contract sum and/or time. Change Orders will include any Field Orders and/or Change Proposal Requests previously approved by the Engineer and accepted by the Owner. The sum and/or time change agreed upon in a Change Order shall not appear on any pay application until the Owner's approval signature has been recorded.

1.16 MEASUREMENT AND PAYMENT

A. General:

1. The total bid price shall cover all work required by the Contract Documents. All costs in connection with the proper and successful completion of the work, including furnishing all materials, equipment, supplies, and appurtenances; providing all construction, installation equipment, and tools; and performing all necessary labor and supervision to fully complete the work, shall be included in the unit and/or lump sum prices bid.

B. Estimated Quantities:

1. All estimated quantities stipulated in the Bid Summary or other Contract Documents are approximate and are to be used only (a) as a basis for estimating the probable cost of the work, and (b) for the purpose of comparing the bids submitted for the work. The actual amounts of work done and materials furnished under unit price items may differ from the estimated quantities. The basis of payment for work and materials will be the actual amount of work done and materials furnished. Contractor agrees that he will make no claim for damages, anticipated profits, or otherwise on account of any difference between the amounts of work actually performed and materials actually furnished and the estimated amounts therefore.
2. Except where otherwise specified, the unit or lump sum price for each item of work that involves excavation or compaction shall include all costs for such work. No direct payment shall be made for site clearing, excavation, or compaction accordance with industry standards and governing regulations.

C. Measurement and Payment Items:

The following work shall be included in the lump sum bid for the removal of the existing bridge, construction of the new abutments and installation of the pre-fabricated bridge. The contractor is responsible for including costs for all work that must be completed in order to construct and set the new pre-fabricated bridge as in accordance with the manufacturer's specifications.

1. Demolition and Removal: The contractor is responsible for the demolition and removal of the existing pedestrian bridge. All materials will be removed from the project area.
2. Clearing: This work shall consist of clearing, removing and disposing of any necessary trees or underbrush necessary to install the abutments and the prefabricated bridge. The contractor shall clear as necessary within the project limits and remove all materials from the project area.
3. Erosion and Sediment Control: It shall be the responsibility of the Contractor to install and maintain adequate erosion control measures to satisfactorily control the retainage of sediment generated by rainfall so that neither streams, drainage pipes nor structures are infiltrated and that adjacent properties are not damaged. The Contractor shall remove any sediment and/or debris deposited in the project area or adjacent streets by runoff from this project area.
4. Excavation: This work shall consist of removing and disposing of surplus material located within the construction limits, including widening cuts and shaping slopes as necessary for preparing the abutment. All work performed shall be in accordance with the requirements of these specifications in conformity with the lines, grades, typical section and cross sections shown on the plans. The abutments shall be backfilled with compacted material in accordance with the plans and specifications.
5. Construction of Abutments: The contractor shall construct the abutments in conformance with the engineering drawings and Bridge Installation and Lifting Instructions provided by Contech

Engineered Solutions, LLC. The abutment and bridge design and drawings are attached hereto as **Attachment 2 & 3**; design calculations are included as **Attachment 4**.

6. Bridge Delivery: The contractor shall be responsible for coordinating with city staff and relocating the prefabricated bridge from the Maintenance and Operations (M&O) Facility to the project site. The M&O Facility is located at 12323 Claude Ct, Northglenn, CO 80241.
7. Installation of the pre-fabricated bridge: The prefabricated bridge was purchased by the City from Contech Engineering Solutions LLC. It will be ready for delivery prior to the City M&O site at the end of January of 2018 and prior to the anticipated contract award for the abutment construction and installation of the bridge. This lump sum price shall include the coordination for delivery from the M&O site to the project. The contractor shall take the bridge and use cranes or other equipment to set the bridge on the abutments. The anchor bolts shall be cast in place to accuracy is critical. The contractor shall connect the bridge in accordance with the manufacturer's specifications and lifting instructions (**Attachment 5**).

PART 2 - PRODUCTS (NOT USED)

PART 3 - EXECUTION

3.1 CONSTRUCTION REQUIREMENTS

- A. Contractor shall take reasonable precaution to prevent damage to existing concrete and landscaping including but not limited to grass or sod, trees, sidewalks, etc., during construction. All landscaping or concrete sidewalk damaged or removed during construction shall be restored or replaced to like new condition. All construction debris shall be removed from the project site within 12 hours of completion of the project.

END OF SECTION 013500



EXHIBIT A
Attachment 2
Abutment Design
8 of 12

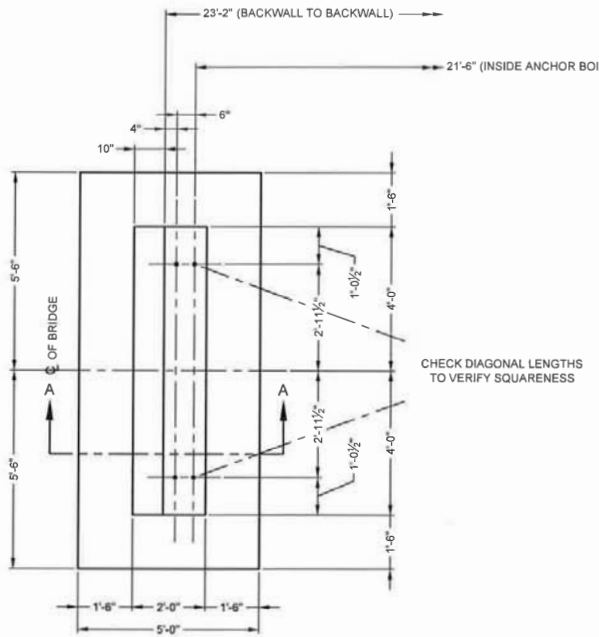

ABUTMENT PLAN

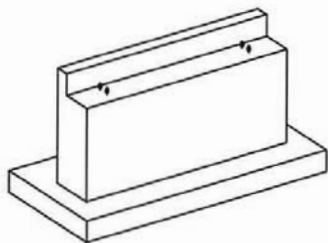

ABUTMENT ISOMETRIC
NOT TO SCALE

CHECK DIAGONAL LENGTHS TO VERIFY SQUARENESS

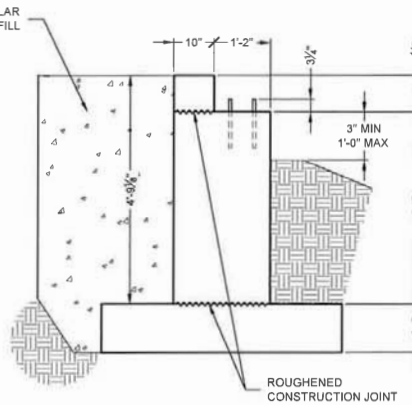

SECTION A - A

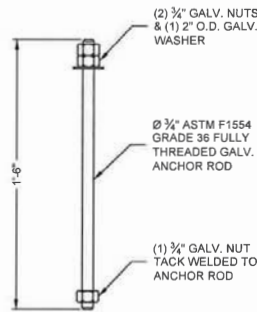

ANCHOR ROD DETAIL
(8) REQUIRED
SUPPLIED BY OTHERS

ABUTMENT DESIGN

- DESIGN IS BASED ON AN ALLOWABLE SOIL BEARING PRESSURE EQUAL TO 1500 PSF IN ACCORDANCE WITH MFG, INC. GEOTECHNICAL REPORT, PROJECT #181239.
- ABUTMENT DESIGN WILL BE BASED ON LOAD REACTIONS FOR CONTECH PEDESTRIAN BRIDGE #569579-010 ONLY.
- ABUTMENT DETAILS SHOWN ARE FOR ABUTMENTS ON EACH SIDE OF THE CROSSING. TOP OF ABUTMENTS TO BE THE SAME ON EITHER SIDE OF THE CROSSING.

FOUNDATION NOTES

- CONTRACTOR TO CONFIRM ABUTMENT ELEVATION AND LOCATION ARE CONSISTENT WITH PROJECT CIVIL PLANS.
- BACKFILLING OF ABUTMENTS TO BE DONE WITH GOOD, CLEAN GRANULAR MATERIAL, PLACED IN 8" LOOSE LIFTS AND COMPACTED TO 95% OF ITS MAXIMUM DRY DENSITY AS SHOWN BY ASTM D-698 STANDARD PROCTOR TEST.
- IF GROUNDWATER IS EVIDENT, THE EXCAVATION SHOULD BE PUMPED DRY BEFORE PLACEMENT OF FORMWORK AND CONCRETE.

GEOTECHNICAL NOTES

- OWNER DESIGNATED INSPECTOR SHALL OBSERVE FOUNDATION EXCAVATIONS PRIOR TO PLACEMENT OF FORMS OR STEEL REINFORCING BARS.
- SCOUR HAS NOT BEEN EVALUATED BY, AND IS NOT THE RESPONSIBILITY OF CONTECH ENGINEERED SOLUTIONS, LLC.
- CONTRACTOR SHALL BE RESPONSIBLE FOR TEMPORARY SHORING, DEWATERING AND CAVING SOILS, IF NECESSARY, DURING EXCAVATIONS.

CONCRETE NOTES

- ALL CONCRETE WORK SHALL CONFORM TO THE REQUIREMENTS OF ACI 318 FOR MATERIALS, QUALITY, MIXING, PLACING, FORMWORK AND DETAILING.
- ALL CONCRETE SHALL ACHIEVE A COMPRESSIVE STRENGTH OF 3,000 PSI @ 28 DAYS.
- MAXIMUM AGGREGATE SIZE SHALL BE 3/4".
- ALL EXPOSED CORNERS OR EDGES SHALL BE FORMED WITH A 1/2" RADIUS CURVED EDGE, U.O.N. ON STRUCTURAL OR ARCHITECTURAL DRAWINGS.
- MAXIMUM WATER CEMENT RATIO SHALL BE 0.5.

CONTRACTOR/OWNER NOTE:
ALL ABUTMENT MATERIALS, INCLUDING ANCHOR RODS, ARE TO BE SUPPLIED BY OTHERS, NOT CONTECH.



CONTECH
CONTRACT
DRAWING



This design and drawings are prepared by the engineer or architect in accordance with the professional seal of the engineer or architect. The engineer or architect is not responsible for the construction of the project. The contractor is responsible for the construction of the project. The engineer or architect is not responsible for the construction of the project. The contractor is responsible for the construction of the project.

NO.	REVISION DESCRIPTION	DATE	MARK	BY

**CONCRETE ABUTMENT
CROKE RESERVOIR
PEDESTRIAN BRIDGE
NORTHGLENN, CO**



DATE:	11/3/2017
DESIGNED:	ATT
DRAWN:	JDM
CHECKED:	ATT
APPROVED:	MJH
PROJECT No.:	569579
SEQUENCE No.:	020
SHEET:	1 OF 2

EXHIBIT A
Scope of Service
12 of 12

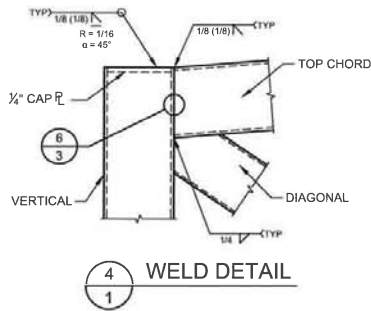

WELD DETAIL

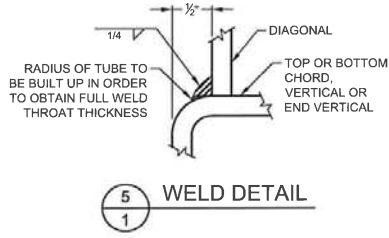

WELD DETAIL

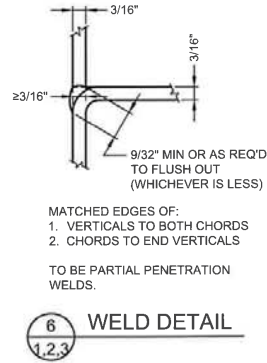

WELD DETAIL

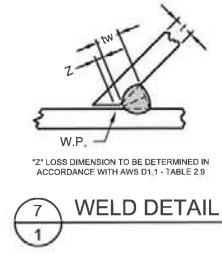

WELD DETAIL

NOTE: IF THE OUTSIDE RADIUS OF THE TUBE IS LESS THAN 1.5 TIMES THE WALL THICKNESS, CONTACT THE ENGINEER FOR APPROPRIATE WELD MODIFICATIONS.

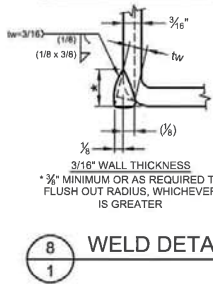

WELD DETAIL

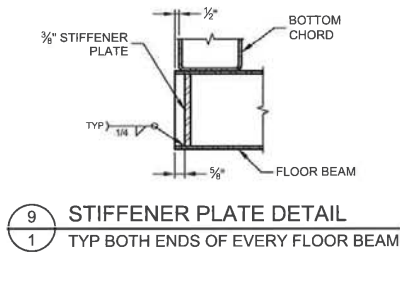

STIFFENER PLATE DETAIL

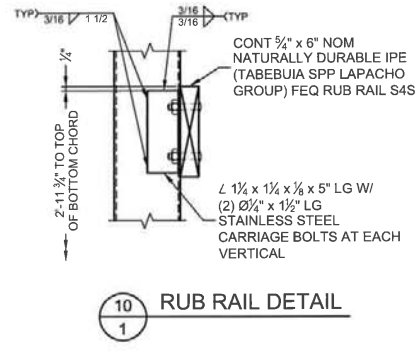

RUB RAIL DETAIL

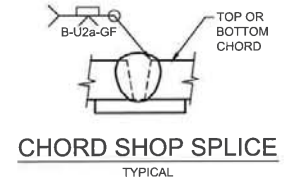

CHORD SHOP SPLICE

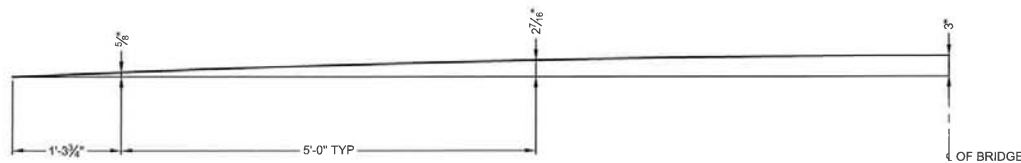

SHOP CAMBER DIAGRAM

CONTECH
CONTRACT
DRAWING



MARK	DATE	REVISION DESCRIPTION	BY

23'-0" x 5'-0"
CROKE RESERVOIR
PEDESTRIAN BRIDGE
NORTHGLENN, CO

CONTECH
ENGINEERED SOLUTIONS LLC
www.contechES.com
8001 Black Canyon Rd North, Northglenn, CO 80639
800.526.5267 303.248.8700 303.248.1167 FAX

CONTINENTAL
BRIDGE

DATE: 10/30/2017
DESIGNED: ATT DRAWN: JDM
CHECKED: ATT APPROVED: MJH
PROJECT No.: 569579 SEQUENCE No.: 010
SHEET: 3 OF 3

I:\AD CONTECH\CP\COMPUTER\PROJECT\ACT\VE\569579\569579-10-CONTINENTAL PEDESTRIAN BRIDGES\FABRICATION\569579-010.DWG 11/02/2017 9:46 AM